



**SYBILLA Ltd.**  
*Managing Environment, Safety & Risk*

16 Ypsilandou, Maroussi GR 151 22 Athens, Greece  
Tel +30210-8024244 / Fax +30210-6141245  
e-mail : [mail@sybilla.gr](mailto:mail@sybilla.gr)

VAT No. EL 095487874



## **CAPACITY STATEMENT INDICATIVE LIST OF CHEMICAL ENGINEERING DESIGN STUDIES**



**SEPTEMBER 2020**

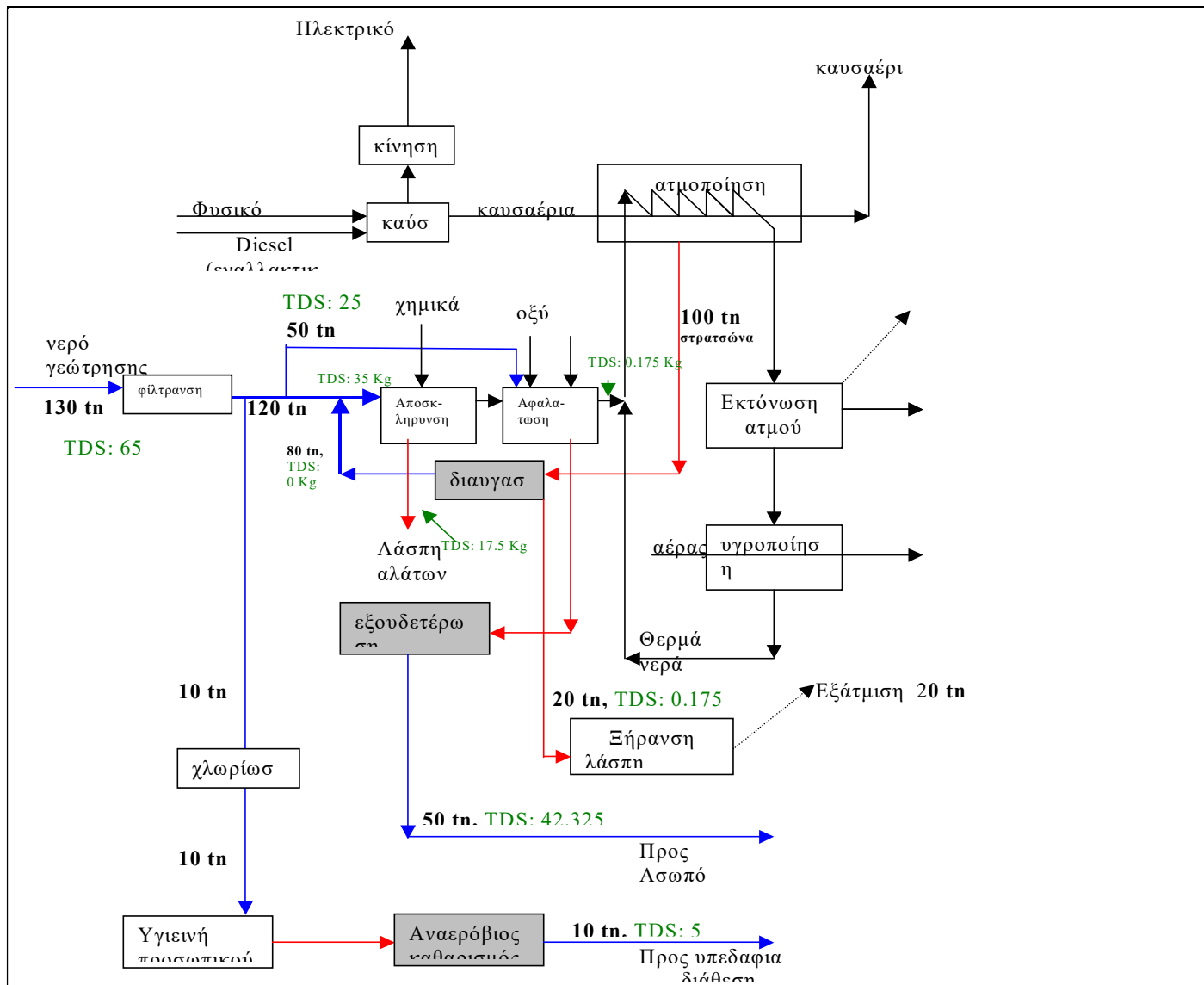

## WASTEWATER TREATMENT AND DISPOSAL FOR A NATURAL GAS POWER PLANT AT THIVA.

CONTACTOR	HERON SA-HPΩN AE
CONTACT AMOUNT	CONFIDENTIAL
YEAR	2001
SHORT DESCRIPTION	CHEMICAL ENGINEERING DESIGN BASIC AND DETAILED STUDY. WASTEWATER TREATMENT AND DISPOSAL STUDY
LOCATION	GREECE/ATHENS-THIVA



**SYBILLA Ltd.**  
*Managing Environment, Safety & Risk*

16 Ypsilandou, Maroussi GR 151 22 Athens, Greece  
 Tel +30210-8024244 / Fax +30210-6141245  
 e-mail : [mail@svbilla.gr](mailto:mail@svbilla.gr)

VAT No. EL 095487874

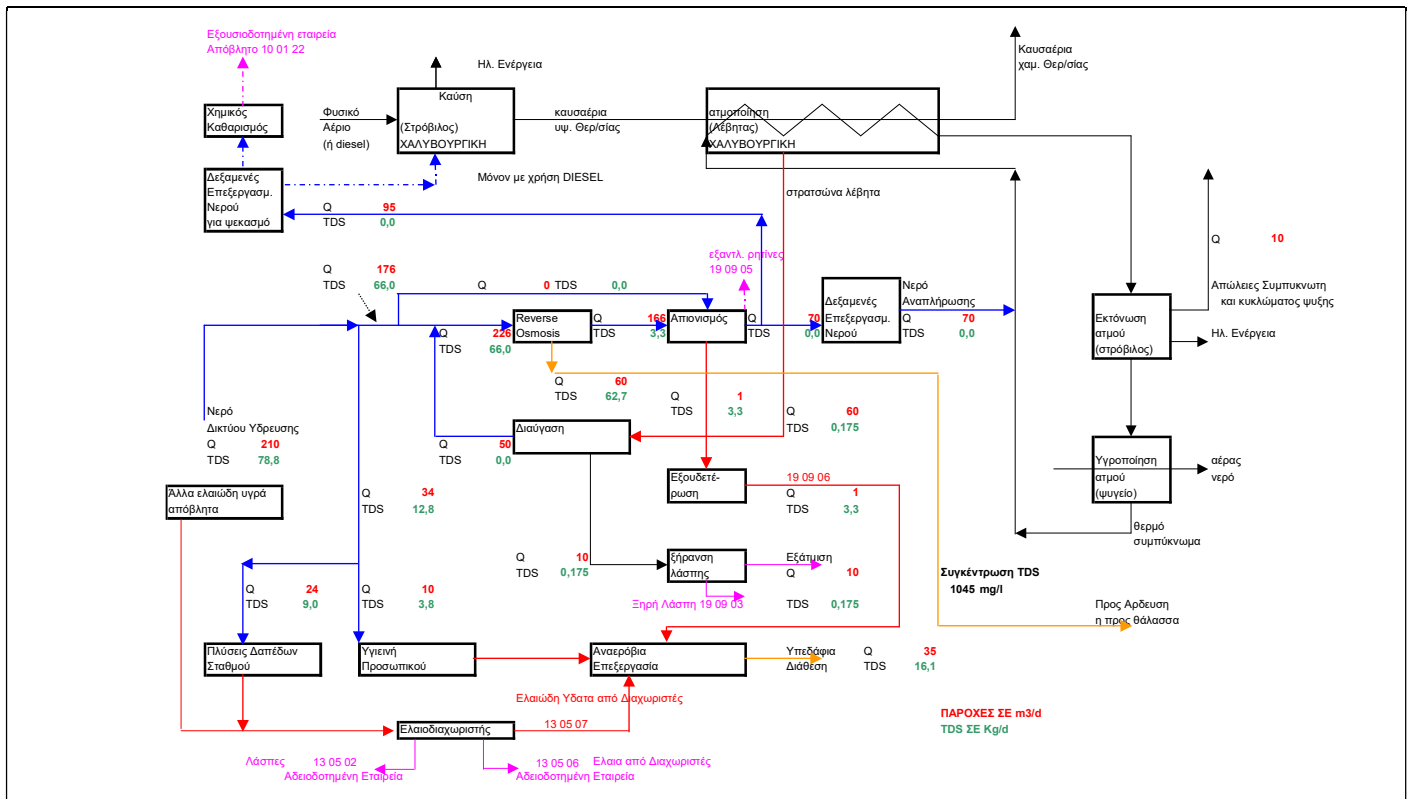

## WASTEWATER TREATMENT AND DISPOSAL STUDY OF A NATURAL GAS 824 MWe AT THE INSTALLATION OF CHALVOURGIKI SA, IN ASPROPYRGOS, ATHENS.

CONTACTOR	CHALVOURGIKI SA-ΧΑΛΥΒΟΥΡΓΙΚΗ ΑΕ
CONTACT AMOUNT	CONFIDENTIAL
YEAR	2006
SHORT DESCRIPTION	CHEMICAL ENGINEERING DESIGN BASIC AND DETAILED STUDY. WASTEWATER TREATMENT AND DISPOSAL STUDY
LOCATION	GREECE/ATHENS



SYBILLA Ltd.  
Managing Environment, Safety & Risk

16 Ypsilandou, Maroussi GR 151 22 Athens, Greece  
Tel +30210-8024244 / Fax +30210-6141245  
e-mail : [mail@svbilla.gr](mailto:mail@svbilla.gr)

VAT No. EL 095487874



## WASTEWATER TREATMENT AND DISPOSAL STUDY FOR A BIOFUELS UNIT OF ARKO BIOFUELS IN ALIARTOS VIOTIA.

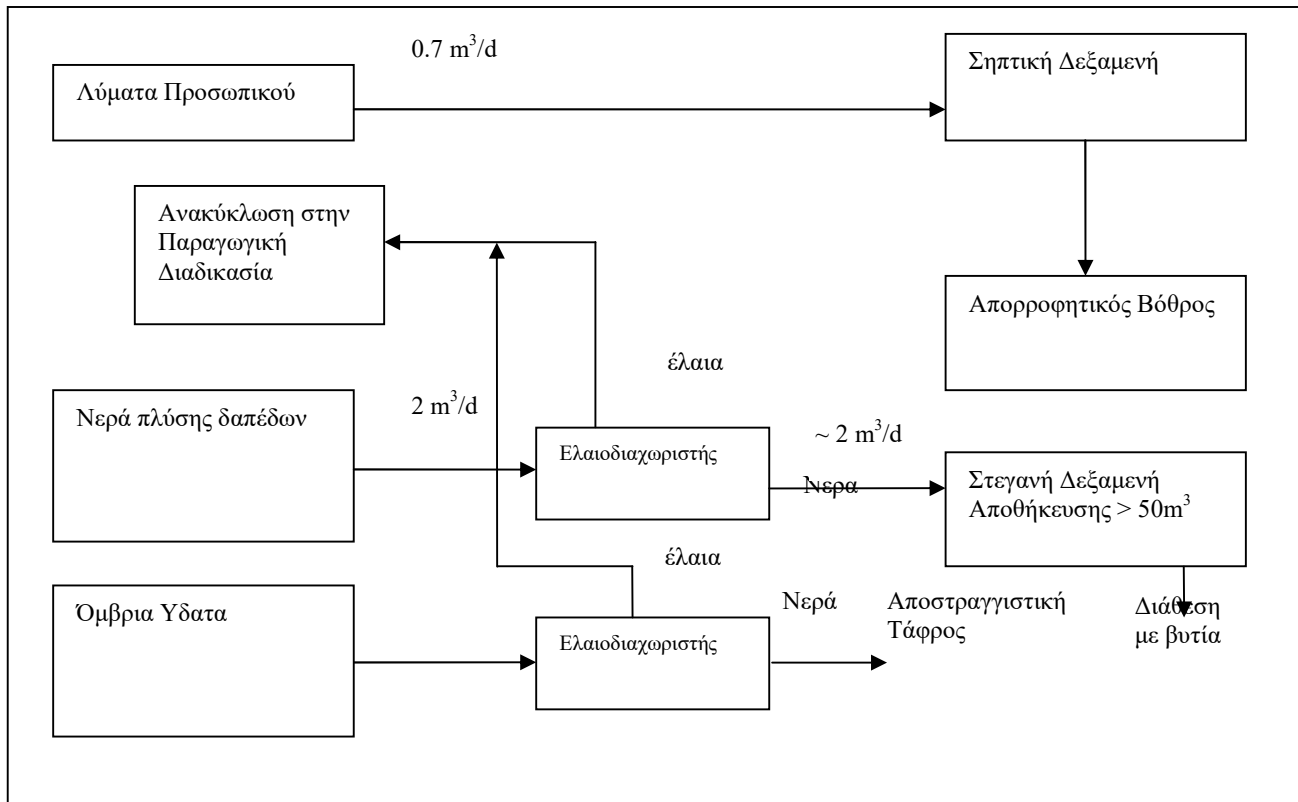

Ισοζύγιο νερού.

CONTACTOR	ARKO BIOFUELS
CONTACT AMOUNT	CONFIDENTIAL
YEAR	2006
SHORT DESCRIPTION	CHEMICAL ENGINEERING DESIGN BASIC AND DETAILED STUDY. WASTEWATER TREATMENT AND DISPOSAL STUDY
LOCATION	GREECE/ATHENS-VIOTIA



SYBILLA Ltd.  
Managing Environment, Safety & Risk

16 Ypsilandou, Maroussi GR 151 22 Athens, Greece  
Tel +30210-8024244 / Fax +30210-6141245  
e-mail : [mail@svbilla.gr](mailto:mail@svbilla.gr)

VAT No. EL 095487874



## WASTEWATER TREATMENT AND DISPOSAL STUDY FOR A NATURAL GAS POWER PLANT 147,9 MWe IN KORINTHOS.

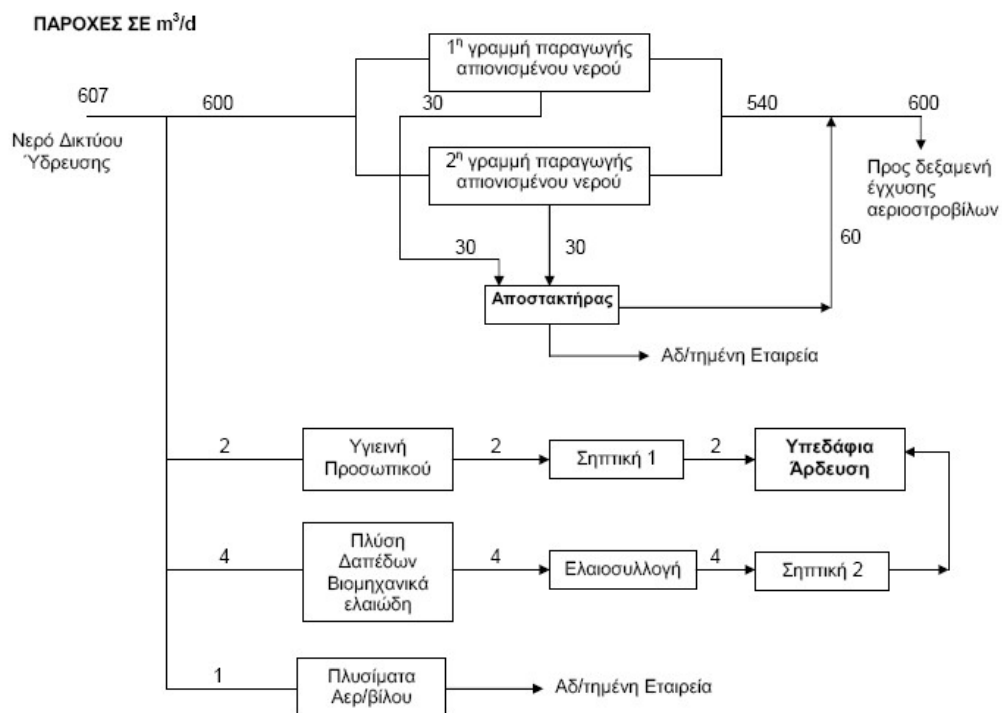

CONTACTOR	BLUE AEGEAN ENERGY AE
CONTACT AMOUNT	CONFIDENTIAL
YEAR	2009
SHORT DESCRIPTION	CHEMICAL ENGINEERING DESIGN BASIC AND DETAILED STUDY. WASTEWATER TREATMENT AND DISPOSAL STUDY
LOCATION	GREECE/ATHENS-KORINTHOS



**SYBILLA Ltd.**  
*Managing Environment, Safety & Risk*

16 Ypsilandou, Maroussi GR 151 22 Athens, Greece  
Tel +30210-8024244 / Fax +30210-6141245  
e-mail : [mail@svbilla.gr](mailto:mail@svbilla.gr)

VAT No. EL 095487874



## **CHEMICAL ENGINEERING DESIGN STUDY FOR A NATURAL GAS POWER PLANT 435 MWe IN XARAININI THIVA**



<b>CONTACTOR</b>	<b>HERON THERMOELECTRICS-ΗΡΩΝ ΘΕΡΜΟΗΛΕΚΤΡΙΚΗ</b>
<b>CONTACT AMOUNT</b>	<b>CONFIDENTIAL</b>
<b>YEAR</b>	<b>2009</b>
<b>SHORT DESCRIPTION</b>	<b>CHEMICAL ENGINEERING DESIGN STUDY</b>
<b>LOCATION</b>	<b>GREECE/ATHENS-THIVA</b>



**SYBILLA Ltd.**  
*Managing Environment, Safety & Risk*

16 Ypsilandou, Maroussi GR 151 22 Athens, Greece  
 Tel +30210-8024244 / Fax +30210-6141245  
 e-mail : [mail@svbilla.gr](mailto:mail@svbilla.gr)

VAT No. EL 095487874



CERTIFIED M.S.  
 ISO 9001:2015  
 ISO 14001:2015

## Detailed Design Study of Chania Urban Waste Recycling and Composting Unit.

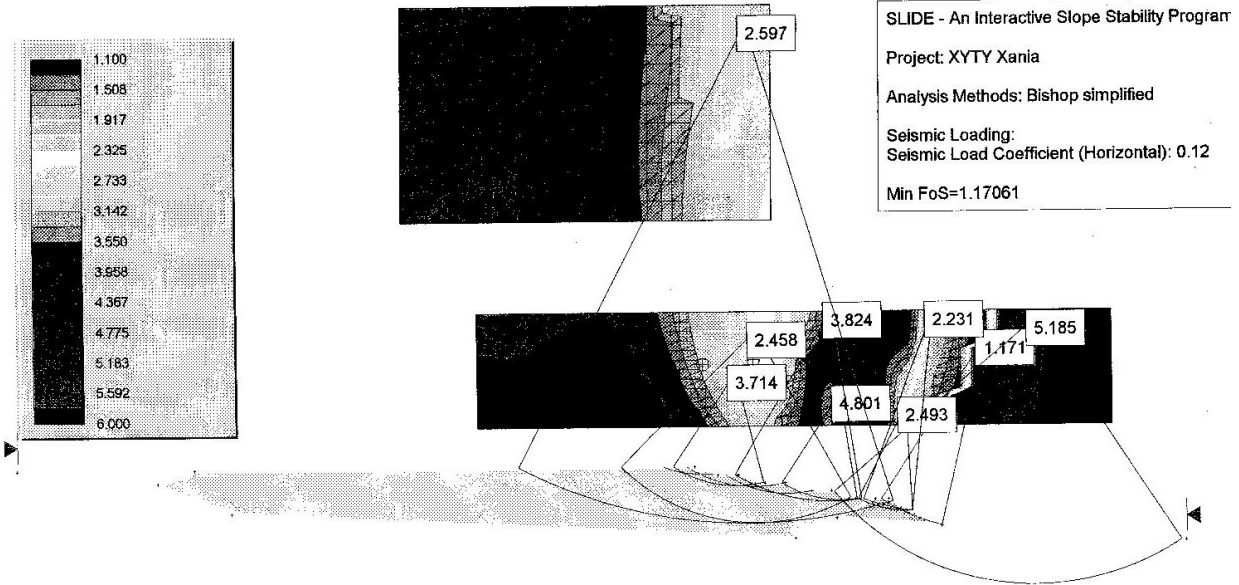

<b>CONTACTOR</b>	<b>K/Ξ ΕΛΤΕΡ ΑΤΕ- ΜΥΤ</b>
<b>CONTACT AMOUNT</b>	<b>CONFIDENTIAL</b>
<b>YEAR</b>	<b>2001</b>
<b>SHORT DESCRIPTION</b>	<b>CHEMICAL ENGINEERING DESIGN BASIC AND DETAILED STUDY. URBAN WASTES RECYCLING AND COMPOST FACILITY</b>
<b>LOCATION</b>	<b>GREECE/ATHENS-CHANIA</b>



**SYBILLA Ltd.**  
*Managing Environment, Safety & Risk*

16 Ypsilandou, Maroussi GR 151 22 Athens, Greece  
Tel +30210-8024244 / Fax +30210-6141245  
e-mail : [mail@svbilla.gr](mailto:mail@svbilla.gr)

VAT No. EL 095487874



## Detailed Study of Heraklion Crete Urban Solid Waste Facility

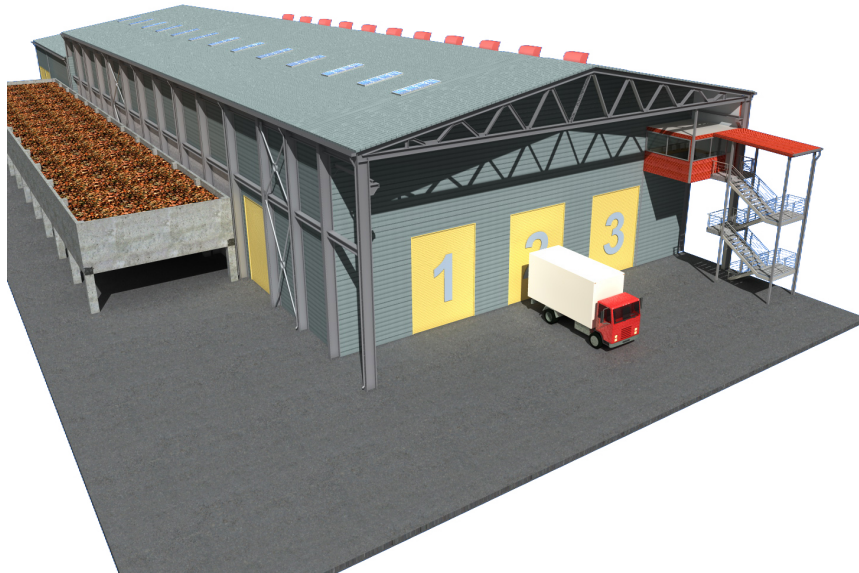

<b>CONTACTOR</b>	<b>«ΚΟΙΝΟΠΡΑΞΙΑ ΔΟΜΙΚΗ ΚΡΗΤΗΣ Α.Ε. - ΑΤΕΣΕ Α.Ε. - E.M.I.T. ERCOLE MARELLI IMPIANTI TECNOLOGICI S.P.A.»</b>
<b>CONTACT AMOUNT</b>	<b>CONFIDENTIAL</b>
<b>YEAR</b>	<b>2007</b>
<b>SHORT DESCRIPTION</b>	<b>CHEMICAL ENGINEERING DESIGN BASIC AND DETAILED STUDY. URBAN SOLID WASTE TREATMENT FACILITY</b>
<b>LOCATION</b>	<b>GREECE/ATHENS-CRETE</b>





**SYBILLA Ltd.**  
*Managing Environment, Safety & Risk*

16 Ypsilandou, Maroussi GR 151 22 Athens, Greece  
 Tel +30210-8024244 / Fax +30210-6141245  
 e-mail : [mail@svbilla.gr](mailto:mail@svbilla.gr)

VAT No. EL 095487874



## DETAILED DESIGN STUDY OF THESSALONIKI URBAN SLUDGE DRYING UNIT

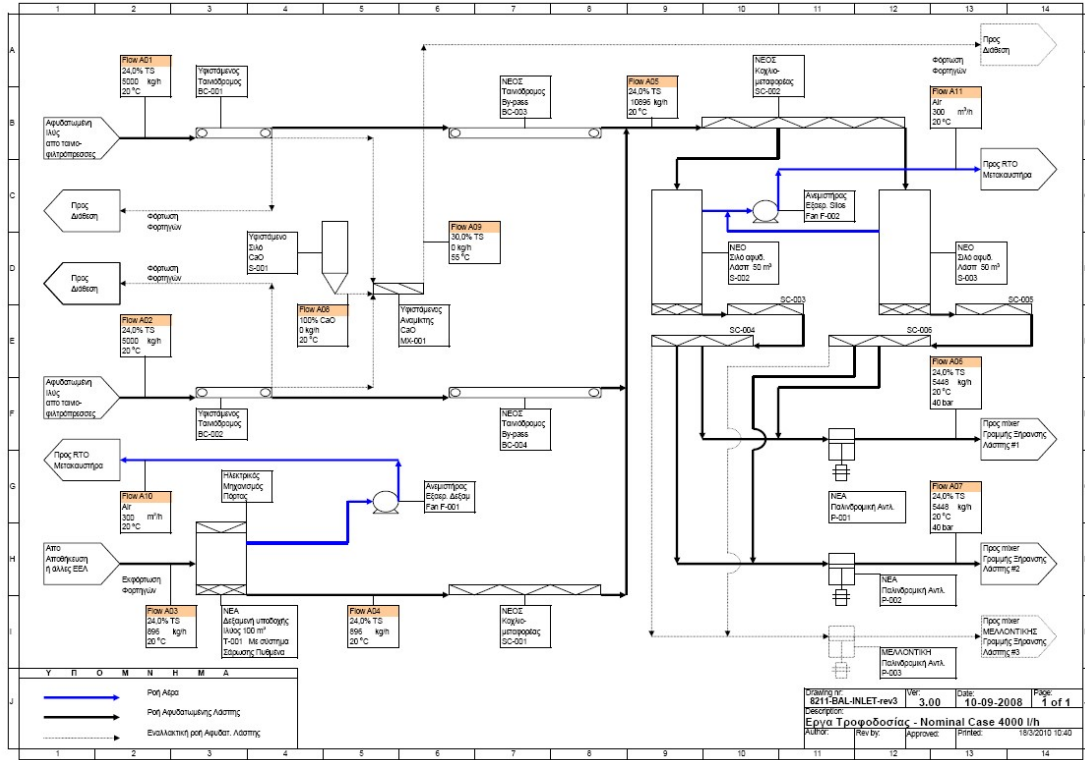

<b>CONTACTOR</b>	<b>XP.Δ.ΚΩΣΤΑΝΤΙΝΙΔΗΣ ΑΕ</b>
<b>CONTACT AMOUNT</b>	<b>CONFIDENTIAL</b>
<b>YEAR</b>	<b>2008-2009</b>
<b>SHORT DESCRIPTION</b>	<b>CHEMICAL ENGINEERING DESIGN BASIC AND DETAILED STUDY. SLUDGE DRYING UNIT</b>
<b>LOCATION</b>	<b>GREECE/ATHENS -THESSALONIKI</b>



SYBILLA Ltd.  
Managing Environment, Safety & Risk

16 Ypsilandou, Maroussi GR 151 22 Athens, Greece  
Tel +30210-8024244 / Fax +30210-6141245  
e-mail : [mail@svbilla.gr](mailto:mail@svbilla.gr)

VAT No. EL 095487874



**CONTRACT: WASTEWATER TREATMENT PLANT OF GEVGELIJA,  
UPDATE OF EXISTING STUDY AND PREPARATION OF  
TENDER DOCUMENT**

***INCEPTION REPORT.***



***PLAN OF GEVGELIJA AND INDUSTRIAL SITE LOCATIONS***

<b>CONTACTOR</b>	<b>F.Y.R.O.M Government</b>
<b>CONTACT AMOUNT</b>	<b>CONFIDENTIAL</b>
<b>YEAR</b>	<b>2004</b>
<b>SHORT DESCRIPTION</b>	<b>CHEMICAL ENGINEERING DESIGN BASIC AND DETAILED STUDY. ORIENTATION REPORT</b>
<b>LOCATION</b>	<b>ATHENS –GEVGELIJA-SKOPIJE</b>





**SYBILLA Ltd.**  
*Managing Environment, Safety & Risk*

16 Ypsilandou, Maroussi GR 151 22 Athens, Greece  
 Tel +30210-8024244 / Fax +30210-6141245  
 e-mail : [mail@svbilla.gr](mailto:mail@svbilla.gr)

VAT No. EL 095487874



**CONTRACT: WASTEWATER TREATMENT PLANT OF GEVGELIJA,  
 UPDATE OF EXISTING STUDY AND PREPARATION OF  
 TENDER DOCUMENT  
 WWTP DESIGN STUDY.**

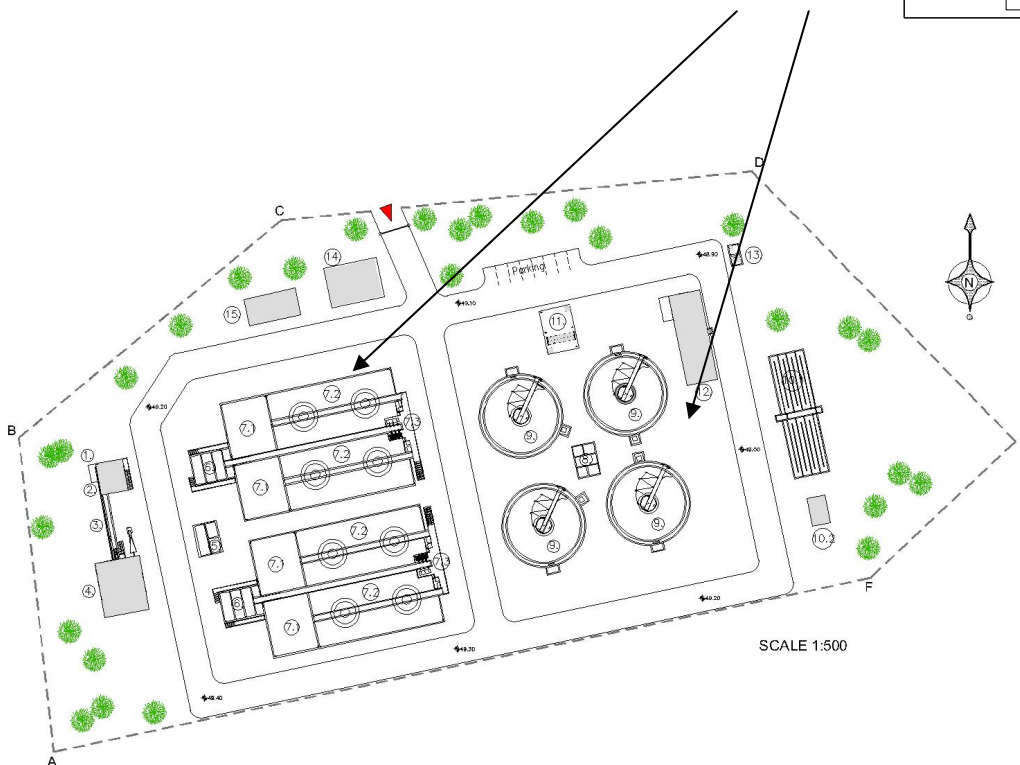
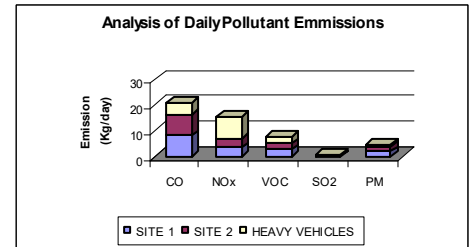

**Spatial Analysis of Total Daily emissions of pollutants per pollutant**

<b>CONTACTOR</b>	<b>F.Y.R.O.M Government</b>
<b>CONTACT AMOUNT</b>	<b>CONFIDENTIAL</b>
<b>YEAR</b>	<b>2004</b>
<b>SHORT DESCRIPTION</b>	<b>CHEMICAL ENGINEERING DESIGN BASIC AND DETAILED STUDY.      DESIGN STUDY URBAN AND INDUSTRIAL WASTEWATER TREATMENT PLANT</b>
<b>LOCATION</b>	<b>ATHENS –GEVGELIJA-SKOPIJE</b>



SYBILLA Ltd.  
Managing Environment, Safety & Risk

16 Ypsilandou, Maroussi GR 151 22 Athens, Greece  
Tel +30210-8024244 / Fax +30210-6141245  
e-mail : [mail@svbilla.gr](mailto:mail@svbilla.gr)

VAT No. EL 095487874



**CONTRACT: WASTEWATER TREATMENT PLANT OF GEVGELIJA,  
UPDATE OF EXISTING STUDY AND PREPARATION OF  
TENDER DOCUMENT  
PREPARATION OF TENDER DOCUMENTS.**



Outflow of the "horse shoe" shaped collector to river Vardar.

<b>CONTACTOR</b>	<b>F.Y.R.O.M Government</b>
<b>CONTACT AMOUNT</b>	<b>CONFIDENTIAL</b>
<b>YEAR</b>	<b>2004</b>
<b>SHORT DESCRIPTION</b>	<b>CHEMICAL ENGINEERING DESIGN BASIC AND DETAILED STUDY. TENDER DOCUMENTS-FIDIC</b>
<b>LOCATION</b>	<b>ATHENS-GEVGELIJA-SKOPIJE</b>



SYBILLA Ltd.  
Managing Environment, Safety & Risk

16 Ypsilandou, Maroussi GR 151 22 Athens, Greece  
Tel +30210-8024244 / Fax +30210-6141245  
e-mail : [mail@svbilla.gr](mailto:mail@svbilla.gr)

VAT No. EL 095487874



## Wastewater Treatment Plant of Tobacco Industry ΠΑΠΑΣΤΡΑΤΟΣ ΑΒΕΣ

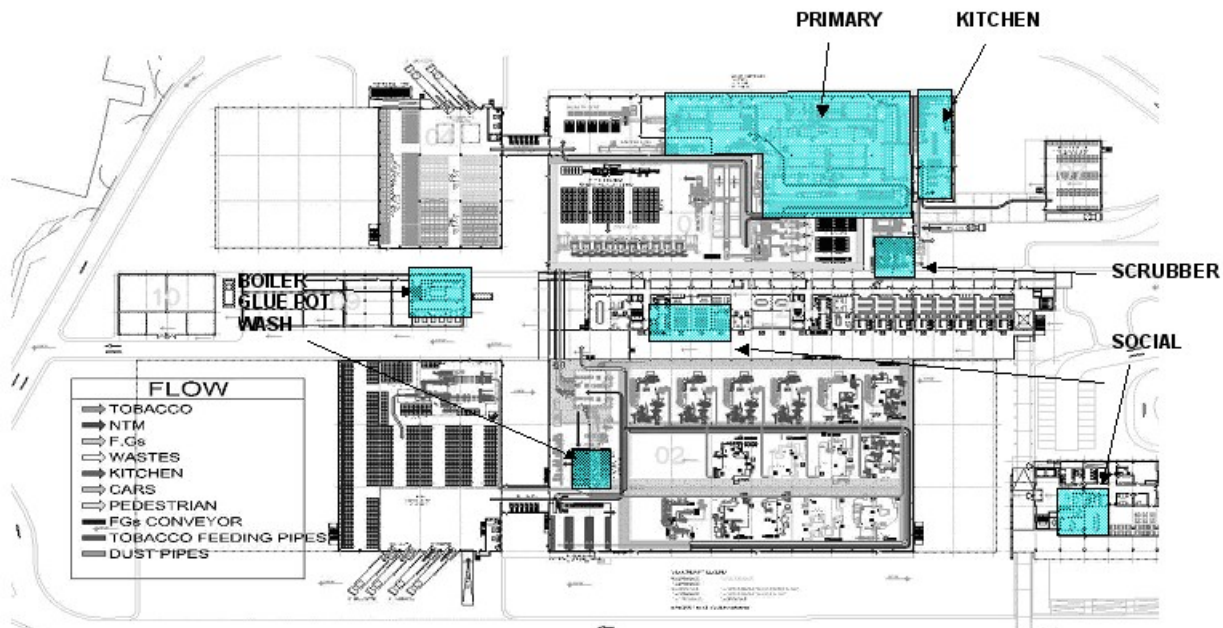

Διάγραμμα ροής παραγωγής υγρών αποβλήτων της υπό μετεγκατάσταση καπνοβιομηχανίας ΠΑΠΑΣΤΡΑΤΟΣ ΑΒΕΣ στον Ασπρόπυργο Αττικής.

CONTACTOR	ΠΑΠΑΣΤΡΑΤΟΣ ΑΒΕΣ
CONTACT AMOUNT	CONFIDENTIAL
YEAR	2005
SHORT DESCRIPTION	CHEMICAL ENGINEERING DESIGN BASIC AND DETAILED STUDY. WWTP
LOCATION	GREECE/ATHENS-ASPROPYRGOS



**SYBILLA Ltd.**  
*Managing Environment, Safety & Risk*

16 Ypsilandou, Maroussi GR 151 22 Athens, Greece  
 Tel +30210-8024244 / Fax +30210-6141245  
 e-mail : [mail@svbilla.gr](mailto:mail@svbilla.gr)

VAT No. EL 095487874



## Tertiary Wastewater Treatment Plant of Industrial area Effluents in Heraklion Crete

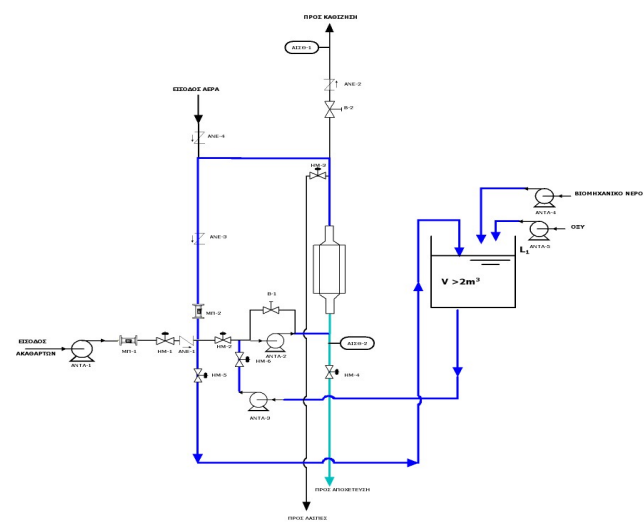

ΠΑΥΣΙΜΟ ΜΕ ΟΞΥ ΚΑΙ ΑΔΕΙΑΣΜΑ ΔΕΞΑΜΕΝΗΣ ΟΞΕΩΣ

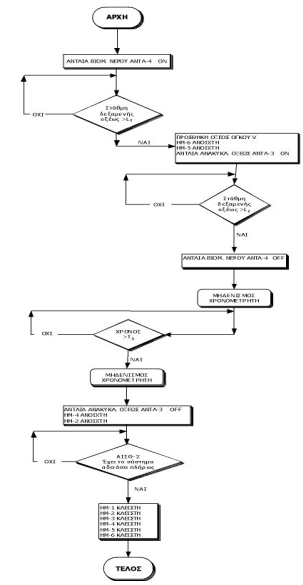

<b>CONTACTOR</b>	<b>ΕΤΒΑ-ΒΙΠΕ Α.Ε.</b>
<b>CONTACT AMOUNT</b>	<b>CONFIDENTIAL</b>
<b>YEAR</b>	<b>2006</b>
<b>SHORT DESCRIPTION</b>	<b>CHEMICAL ENGINEERING DESIGN BASIC STUDY. Tertiary Treatment WWTP</b>
<b>LOCATION</b>	<b>GREECE/ATHENS-HERAKLION CRETE</b>



**SYBILLA Ltd.**  
*Managing Environment, Safety & Risk*

16 Ypsilandou, Maroussi GR 151 22 Athens, Greece  
 Tel +30210-8024244 / Fax +30210-6141245  
 e-mail : [mail@svbilla.gr](mailto:mail@svbilla.gr)

VAT No. EL 095487874



## Tertiary Wastewater Treatment Plant of Industrial area Effluents in Heraklion Crete

### DETAILED STUDY OF

- 1: ELECTROCHEMICAL TERTIARY TREATMENT**
- 2: SLUDGE SANITIZATION UNIT**

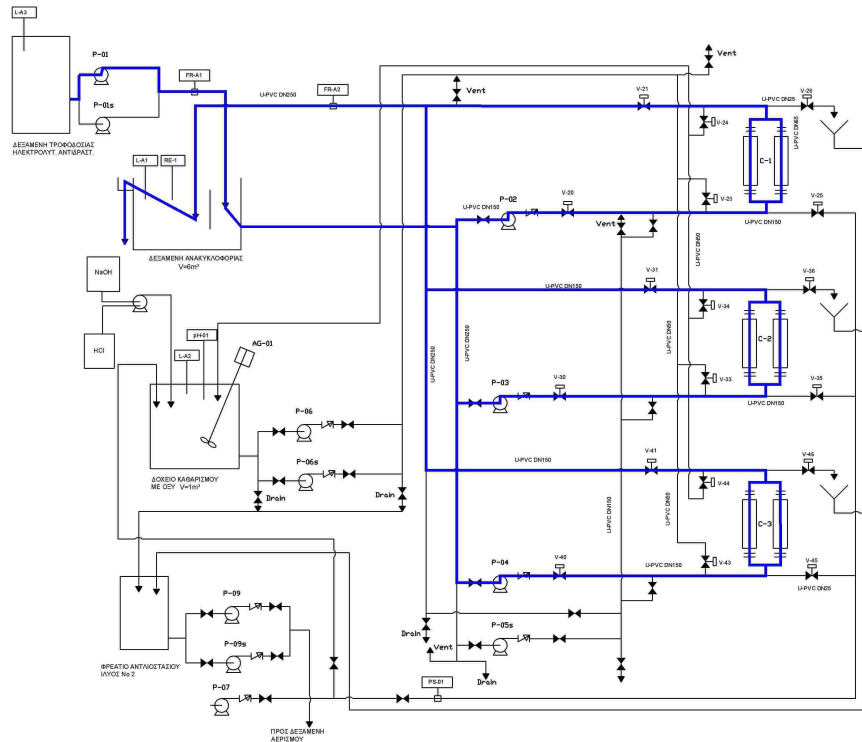

<b>CONTACTOR</b>	<b>ΕΤΒΑ-ΒΙΠΕ ΑΕ/ΚΟΙΝΟΠΡΑΞΙΑ Τ.Ε.Κ. ΘΕΣ/ΝΙΚΗΣ Α.Ε. – ΚΕΛΕΣΗΣ</b>
<b>CONTACT AMOUNT</b>	<b>CONFIDENTIAL</b>
<b>YEAR</b>	<b>2007</b>
<b>SHORT DESCRIPTION</b>	<b>CHEMICAL ENGINEERING DESIGN BASIC AND DETAILED STUDY.</b>
<b>LOCATION</b>	<b>GREECE/ATHENS-HERAKLION CRETE</b>





SYBILLA Ltd.  
Managing Environment, Safety & Risk

16 Ypsilandou, Maroussi GR 151 22 Athens, Greece  
Tel +30210-8024244 / Fax +30210-6141245  
e-mail : [mail@svbilla.gr](mailto:mail@svbilla.gr)

VAT No. EL 095487874



## AIR EMISSIONS AND WASTEWATER TREATMENT STUDY OF ELECTRICITY PRODUCING FACILITY IN LIMNOS

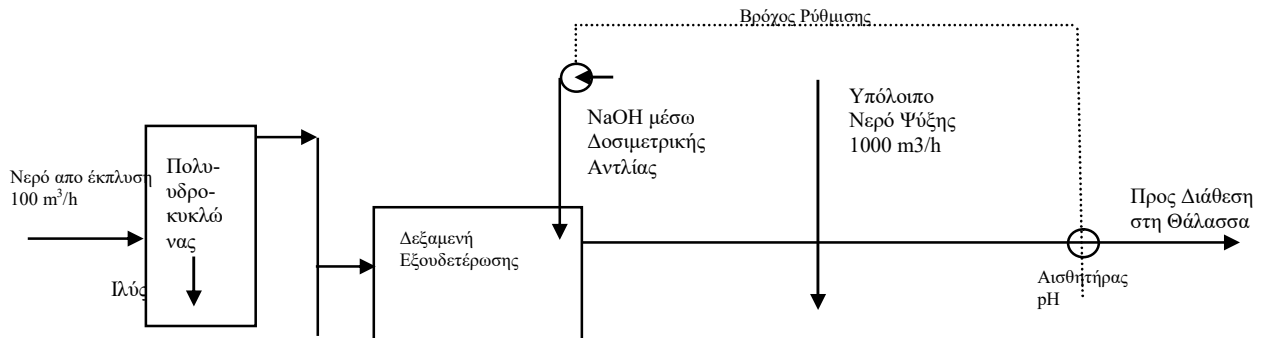

CONTACTOR	ΔΕΗ ΑΕ/ΚΙΤΤΙΒΑΚΕ ΑΕ
CONTACT AMOUNT	CONFIDENTIAL
YEAR	2007
SHORT DESCRIPTION	CHEMICAL ENGINEERING DESIGN BASIC AND DETAILED STUDY.
LOCATION	GREECE/ATHENS-LIMNOS



**SYBILLA Ltd.**  
*Managing Environment, Safety & Risk*

16 Ypsilandou, Maroussi GR 151 22 Athens, Greece  
 Tel +30210-8024244 / Fax +30210-6141245  
 e-mail : [mail@svbilla.gr](mailto:mail@svbilla.gr)

VAT No. EL 095487874



## ALTERNATIVE TREATMENT OF GREEK OLIVE OIL EXTRACTION FACILITIES

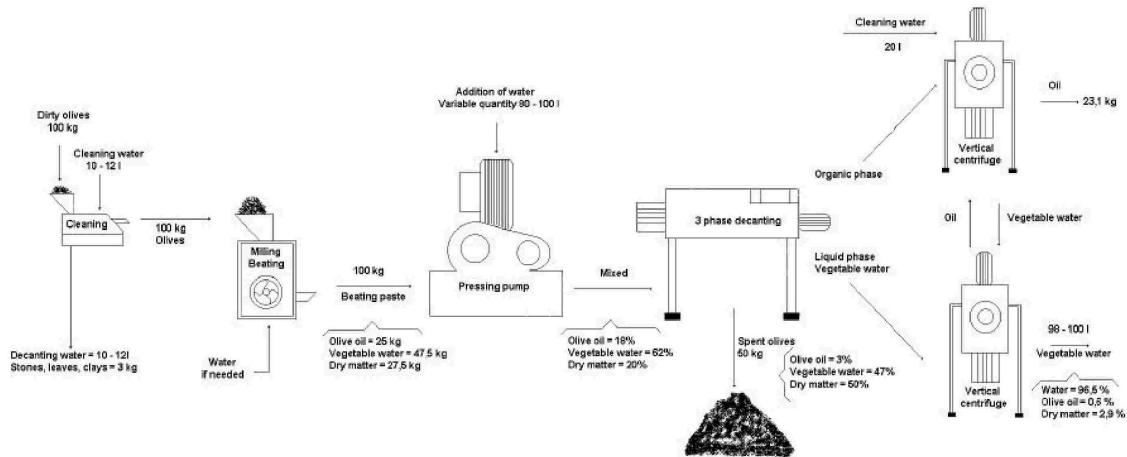

<b>CONTACTOR</b>	<b>ΕΛΛΙΟΥΡΓΙΚΗ ΑΕ</b>
<b>CONTACT AMOUNT</b>	<b>CONFIDENTIAL</b>
<b>YEAR</b>	<b>2007</b>
<b>SHORT DESCRIPTION</b>	<b>CHEMICAL ENGINEERING DESIGN BASIC STUDY.</b>
<b>LOCATION</b>	<b>GREECE/ATHENS-CRETE-PELOPONISOS-CHALKIDIKH</b>



**SYBILLA Ltd.**  
*Managing Environment, Safety & Risk*

16 Ypsilandou, Maroussi GR 151 22 Athens, Greece  
 Tel +30210-8024244 / Fax +30210-6141245  
 e-mail : [mail@svbilla.gr](mailto:mail@svbilla.gr)

VAT No. EL 095487874



CERTIFIED M.S.  
 ISO 9001:2015  
 ISO 14001:2015

## ALTERNATIVE TREATMENT OF GREEK OLIVE OIL EXTRACTION FACILITIES.

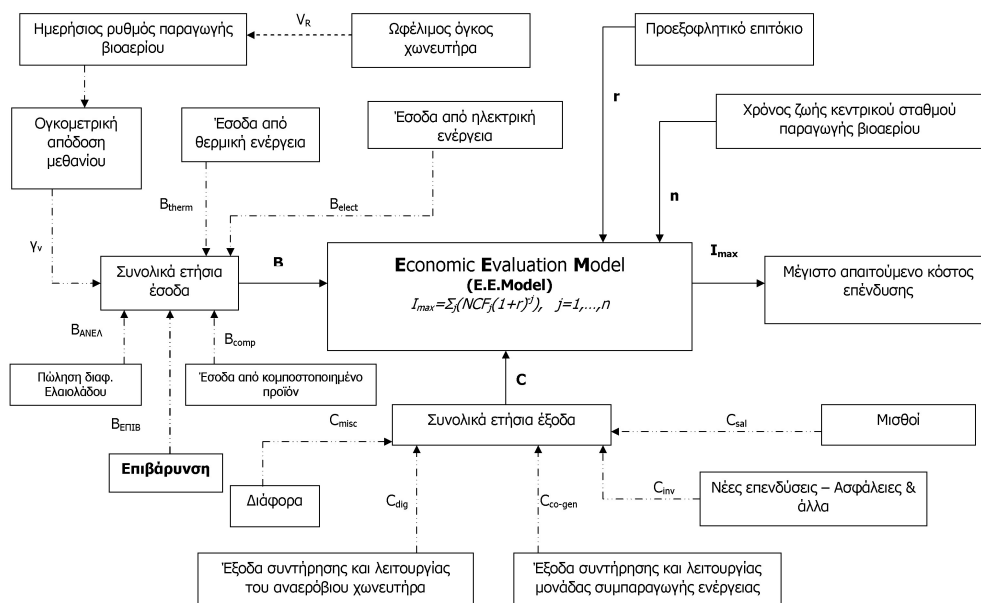

<b>CONTACTOR</b>	<b>ΕΛΑΙΟΥΡΓΙΚΗ ΑΕ</b>
<b>CONTACT AMOUNT</b>	<b>CONFIDENTIAL</b>
<b>YEAR</b>	<b>2007</b>
<b>SHORT DESCRIPTION</b>	<b>TECHNOECONOMIC FEASIBILITY STUDY</b>
<b>LOCATION</b>	<b>GREECE/ATHENS-CRETE-PELOPONISOS-CHALKIDIKH</b>



**SYBILLA Ltd.**  
*Managing Environment, Safety & Risk*

16 Ypsilandou, Maroussi GR 151 22 Athens, Greece  
 Tel +30210-8024244 / Fax +30210-6141245  
 e-mail : [mail@svbilla.gr](mailto:mail@svbilla.gr)

VAT No. EL 095487874



## Wastewater Treatment Plant of EUROPA PROFIL ΑΛΟΥΜΙΝΙΟΥ ΑΕΒΕ IN Greater Athens Area.

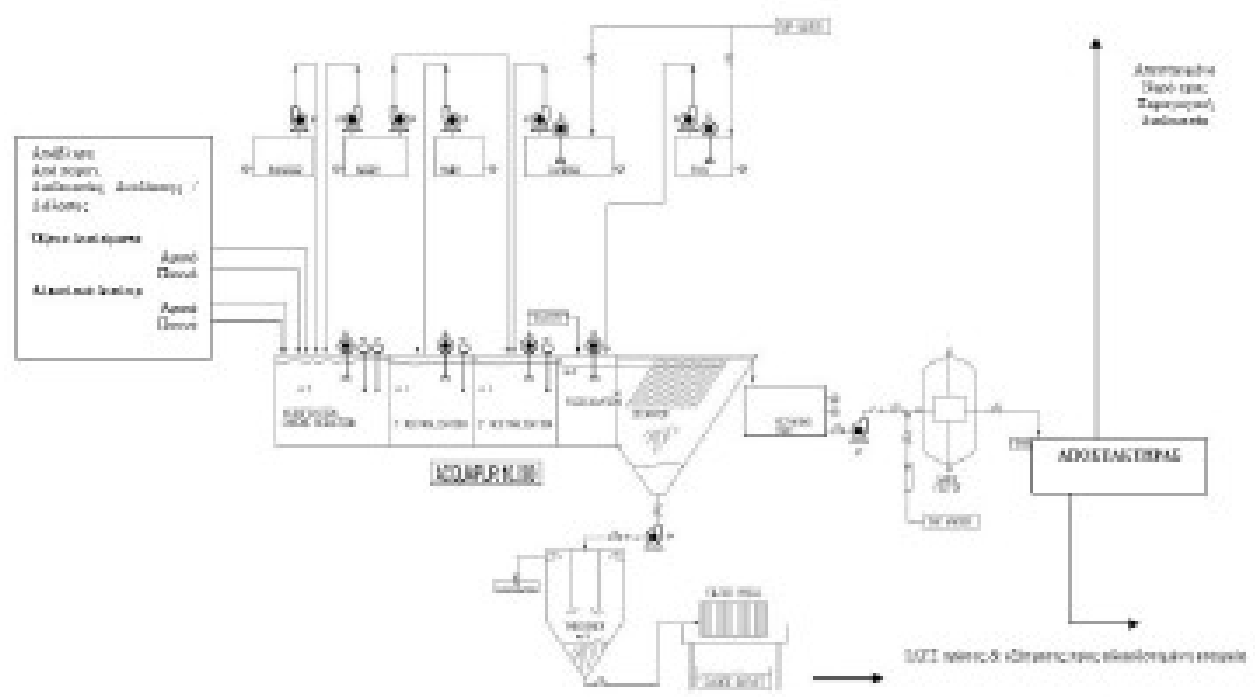

<b>CONTACTOR</b>	<b>EUROPA PROFIL ΑΛΟΥΜΙΝΙΟΥ ΑΕΒΕ</b>
<b>CONTACT AMOUNT</b>	<b>CONFIDENTIAL</b>
<b>YEAR</b>	<b>2009</b>
<b>SHORT DESCRIPTION</b>	<b>CHEMICAL ENGINEERING DESIGN BASIC AND DETAILED STUDY.</b>
<b>LOCATION</b>	<b>Greece/ATHENS</b>



SYBILLA Ltd.  
Managing Environment, Safety & Risk

16 Ypsilandou, Maroussi GR 151 22 Athens, Greece  
Tel +30210-8024244 / Fax +30210-6141245  
e-mail : [mail@svbilla.gr](mailto:mail@svbilla.gr)

VAT No. EL 095487874



## Wastewater Treatment Plant of Natural Gas electricity producing unit 147,9 MWe of BLUE AEGEAN ENERGY AE in Corinthia.

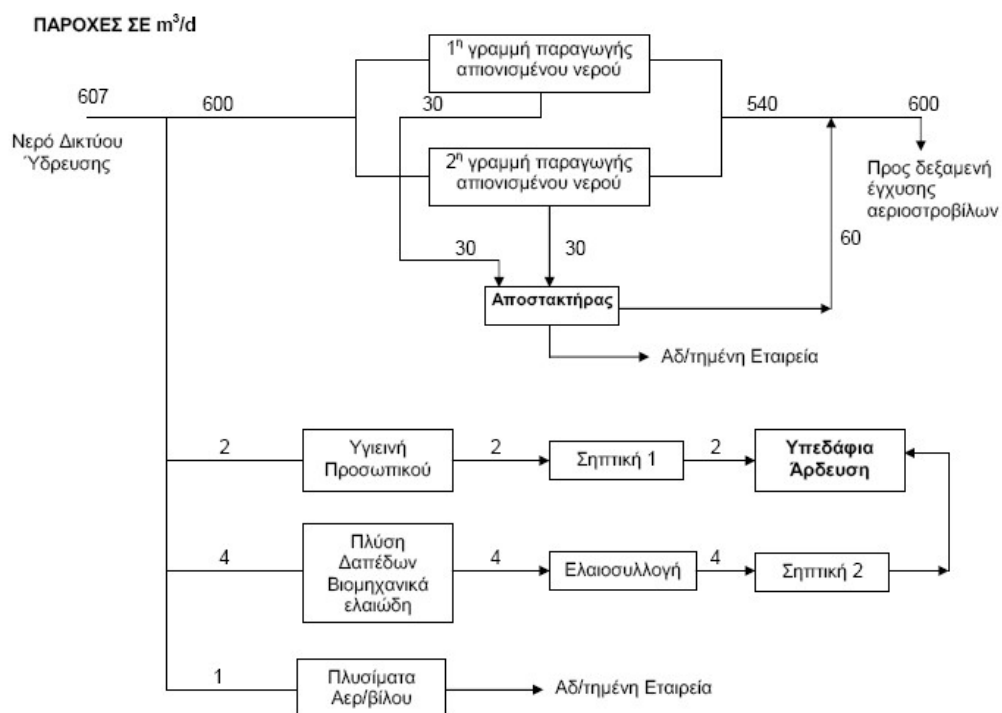

CONTACTOR	BLUE AEGEAN ENERGY AE
CONTACT AMOUNT	CONFIDENTIAL
YEAR	2009
SHORT DESCRIPTION	CHEMICAL ENGINEERING DESIGN BASIC AND DETAILED STUDY.
LOCATION	GREECE/ATHENS-CORINTIA



**SYBILLA Ltd.**  
*Managing Environment, Safety & Risk*

16 Ypsilandou, Maroussi GR 151 22 Athens, Greece  
 Tel +30210-8024244 / Fax +30210-6141245  
 e-mail : [mail@svbilla.gr](mailto:mail@svbilla.gr)

VAT No. EL 095487874



## Wastewater Treatment Plant of Greek Aerospace Industry in Greater Athens Area

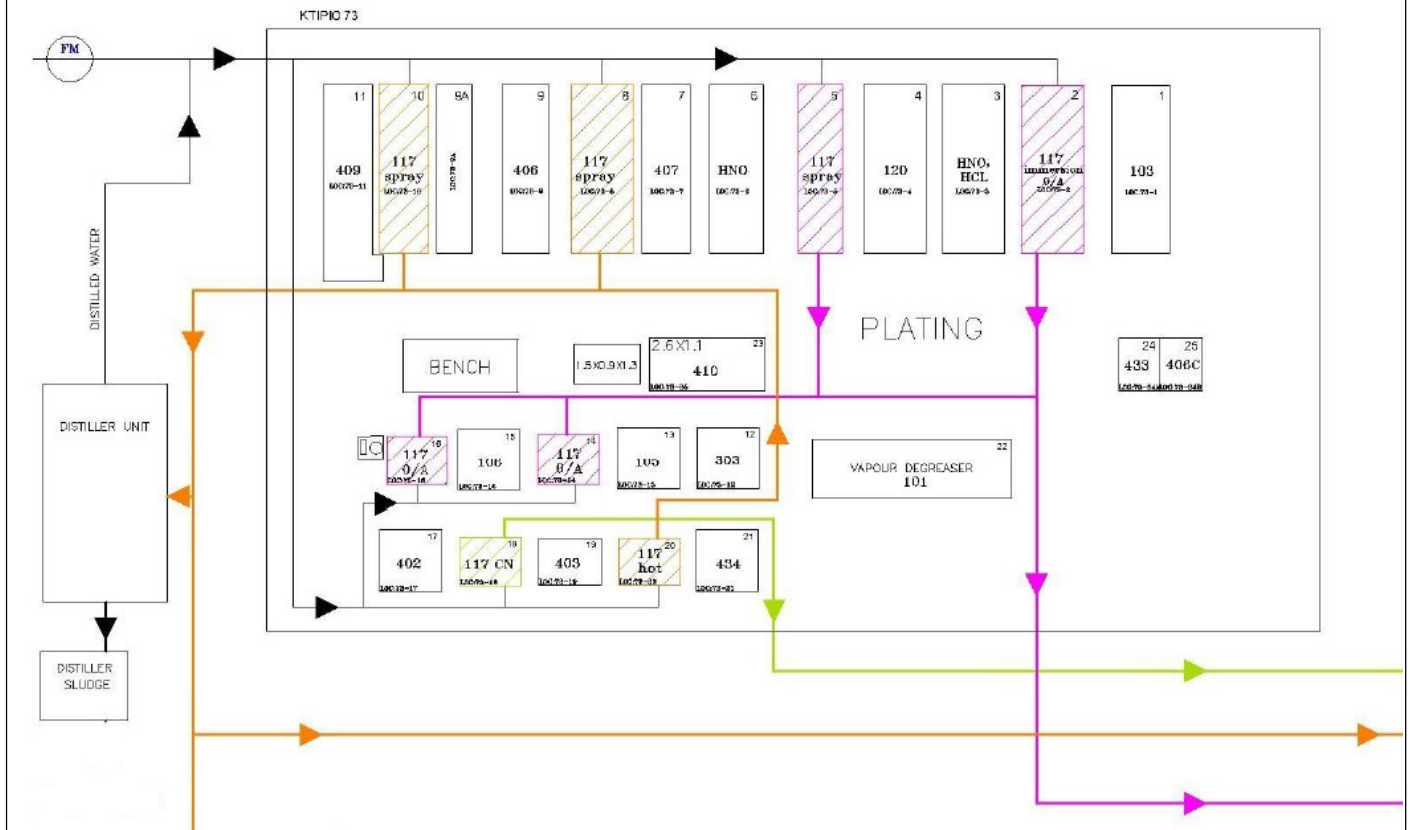

<b>CONTACTOR</b>	<b>GREEK AEROSPACE INDUSTRY AE</b>
<b>CONTACT AMOUNT</b>	<b>CONFIDENTIAL</b>
<b>YEAR</b>	<b>2010</b>
<b>SHORT DESCRIPTION</b>	<b>CHEMICAL ENGINEERING DESIGN BASIC AND DETAILED STUDY.</b>
<b>LOCATION</b>	<b>GREECE/GREATER ATHENS AREA</b>



**SYBILLA Ltd.**  
*Managing Environment, Safety & Risk*

16 Ypsilandou, Maroussi GR 151 22 Athens, Greece  
Tel +30210-8024244 / Fax +30210-6141245  
e-mail : [mail@svbilla.gr](mailto:mail@svbilla.gr)

VAT No. EL 095487874



## Wastewater Treatment Plant of Servia Kozani

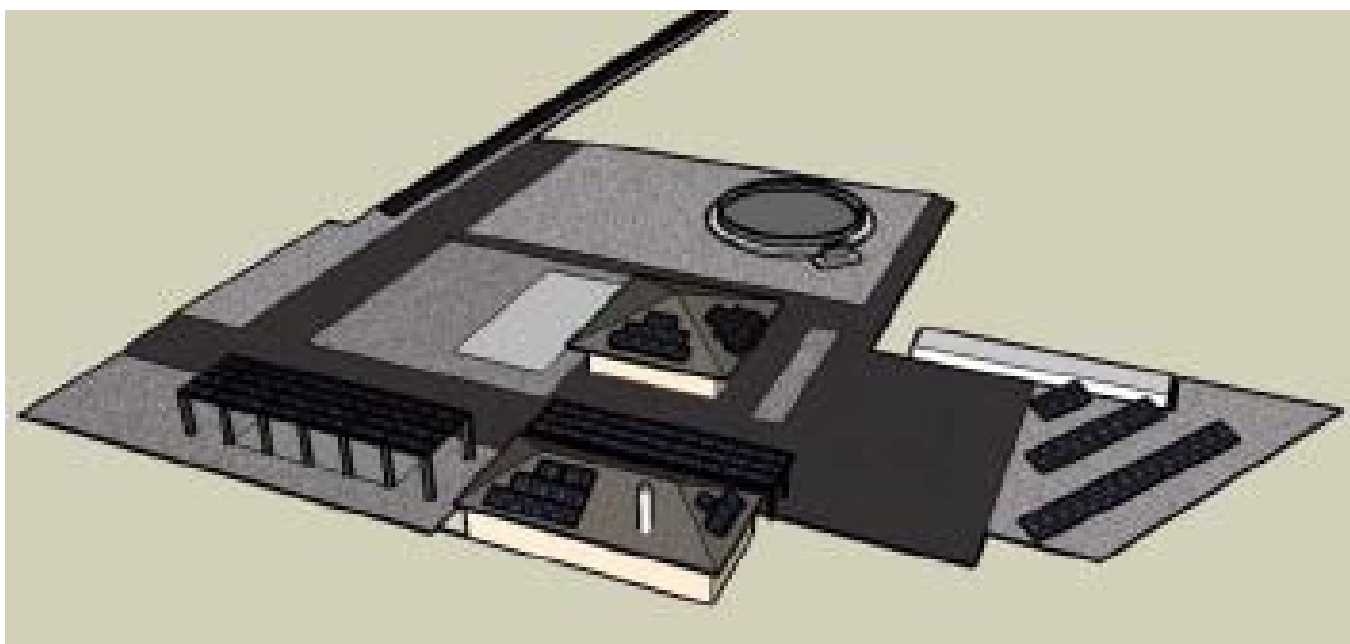

<b>CONTACTOR</b>	<b>K/Ε ΛΑΜΔΑ ΤΕΧΝΙΚΗ Α.Ε. – ΜΑΛΛΙΟΝΤΑ ΑΤΕ</b>
<b>CONTACT AMOUNT</b>	<b>CONFIDENTIAL</b>
<b>YEAR</b>	<b>2011</b>
<b>SHORT DESCRIPTION</b>	<b>CHEMICAL ENGINEERING DESIGN BASIC AND DETAILED STUDY.</b>
<b>LOCATION</b>	<b>GREECE/ATHENS-- KOZANI</b>



SYBILLA Ltd.  
Managing Environment, Safety & Risk

16 Ypsilandou, Maroussi GR 151 22 Athens, Greece  
Tel +30210-8024244 / Fax +30210-6141245  
e-mail : [mail@svbilla.gr](mailto:mail@svbilla.gr)

VAT No. EL 095487874



## Wastewater Treatment Plant of Megalou Alexandrou Pella

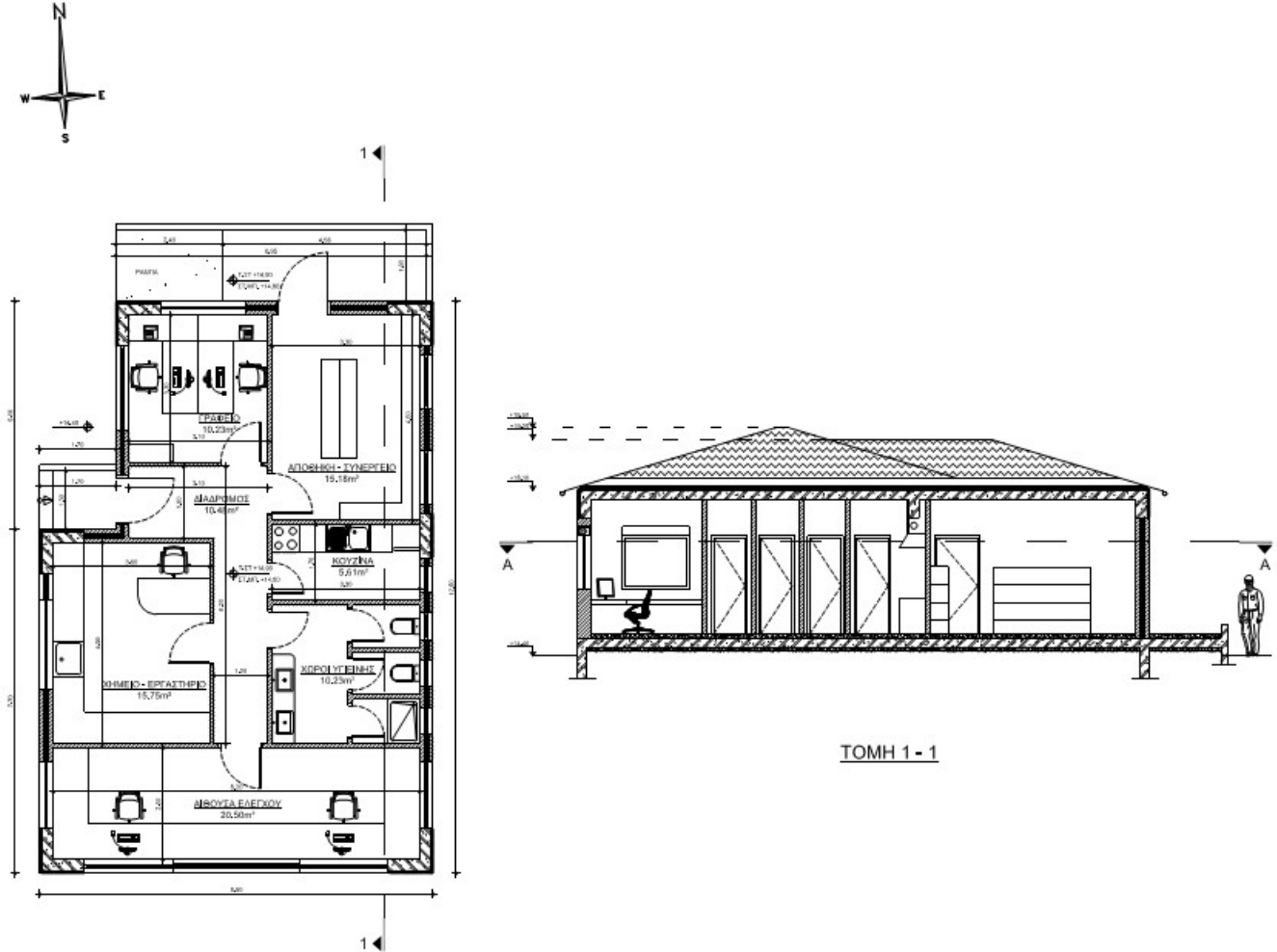

CONTACTOR	ΜΑΚΕΔΟΝΙΚΕΣ ΓΡΑΜΜΕΣ ΕΤΕ
CONTACT AMOUNT	CONFIDENTIAL
YEAR	2014
SHORT DESCRIPTION	CHEMICAL ENGINEERING DESIGN BASIC AND DETAILED STUDY.
LOCATION	GREECE/PELLA





**SYBILLA Ltd.**  
*Managing Environment, Safety & Risk*

16 Ypsilandou, Maroussi GR 151 22 Athens, Greece  
 Tel +30210-8024244 / Fax +30210-6141245  
 e-mail : [mail@svbilla.gr](mailto:mail@svbilla.gr)



## Wastewater Treatment Plant of Leonidio Arkadia

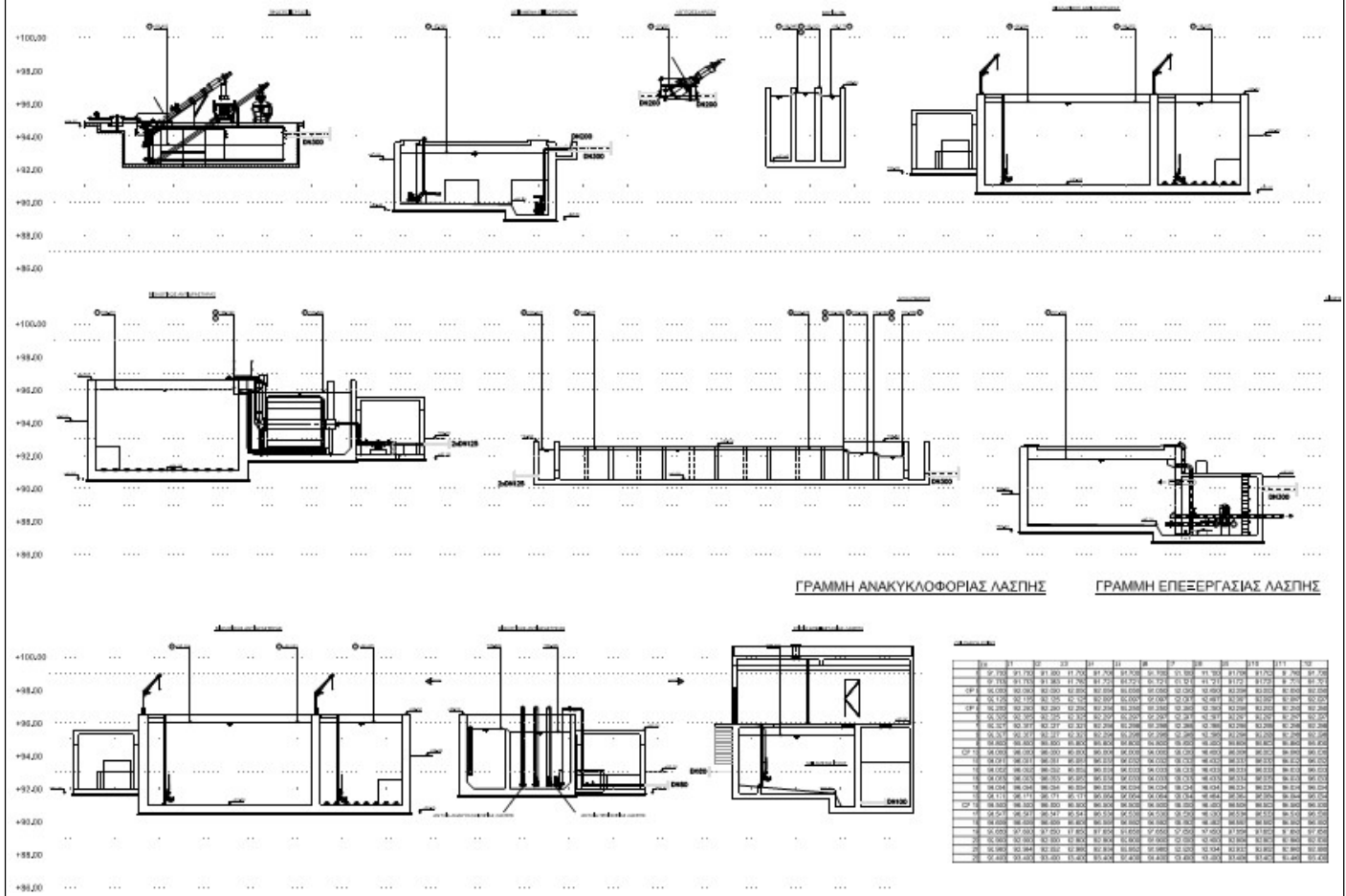

<b>CONTACTOR</b>	<b>Κ/Ξ ΑΚΩΝ ΤΕΧΝΙΚΗ Α.Ε. - ΠΟΜΒΟΣ Α.Ε. ΕΤΕ</b>
<b>CONTACT AMOUNT</b>	<b>CONFIDENTIAL</b>
<b>YEAR</b>	<b>2015</b>
<b>SHORT DESCRIPTION</b>	<b>CHEMICAL ENGINEERING DESIGN BASIC AND DETAILED STUDY.</b>
<b>LOCATION</b>	<b>GREECE/ATHENS-- LEONIDIO</b>



**SYBILLA Ltd.**  
*Managing Environment, Safety & Risk*

16 Ypsilandou, Maroussi GR 151 22 Athens, Greece  
Tel +30210-8024244 / Fax +30210-6141245  
e-mail : [mail@svbilla.gr](mailto:mail@svbilla.gr)

VAT No. EL 095487874



## TECHNICAL STUDY OF SAMOS LANDFILLS WWTP FACILITIES

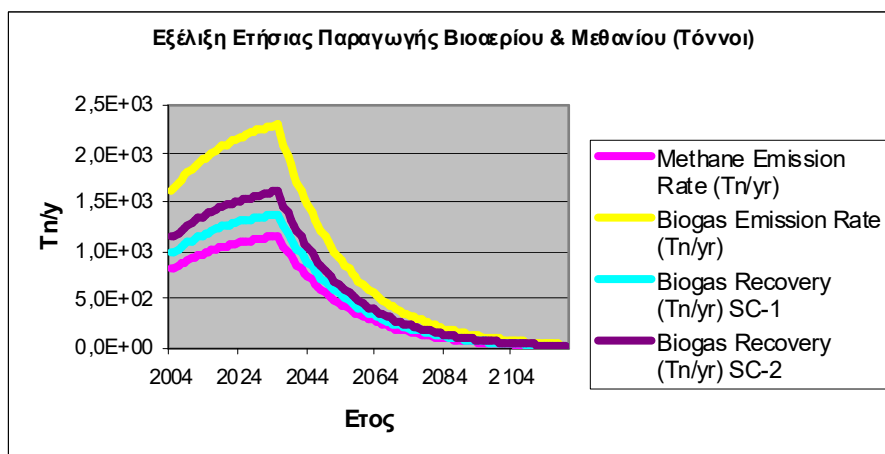

<b>CONTACTOR</b>	<b>Κ/Ξ ΥΔΡΟΔΥΝΑΜΙΚΗ ΑΕ – ΕΥΒΟΚΑΤ ΑΕ</b>
<b>CONTACT AMOUNT</b>	<b>CONFIDENTIAL</b>
<b>YEAR</b>	<b>2004</b>
<b>SHORT DESCRIPTION</b>	<b>CHEMICAL ENGINEERING DESIGN BASIC AND DETAILED WWTP LANDFIL STUDY.</b>
<b>LOCATION</b>	<b>GREECE/ATHENS-SAMOS</b>