



SYBILLA Ltd.  
Managing Environment, Safety & Risk

16 Ypsilandou, Maroussi GR 151 22 Athens, Greece  
Tel +30210-8024244 / Fax +30210-6141245  
e-mail : [mail@svbilla.gr](mailto:mail@svbilla.gr)

VAT No. EL 095487874



## CAPABILITY STATEMENT

### SANITARY LANDFILL SITES, TRANSPORT SITES AND INDUSTRIAL WASTE STORAGE SITES STUDIES

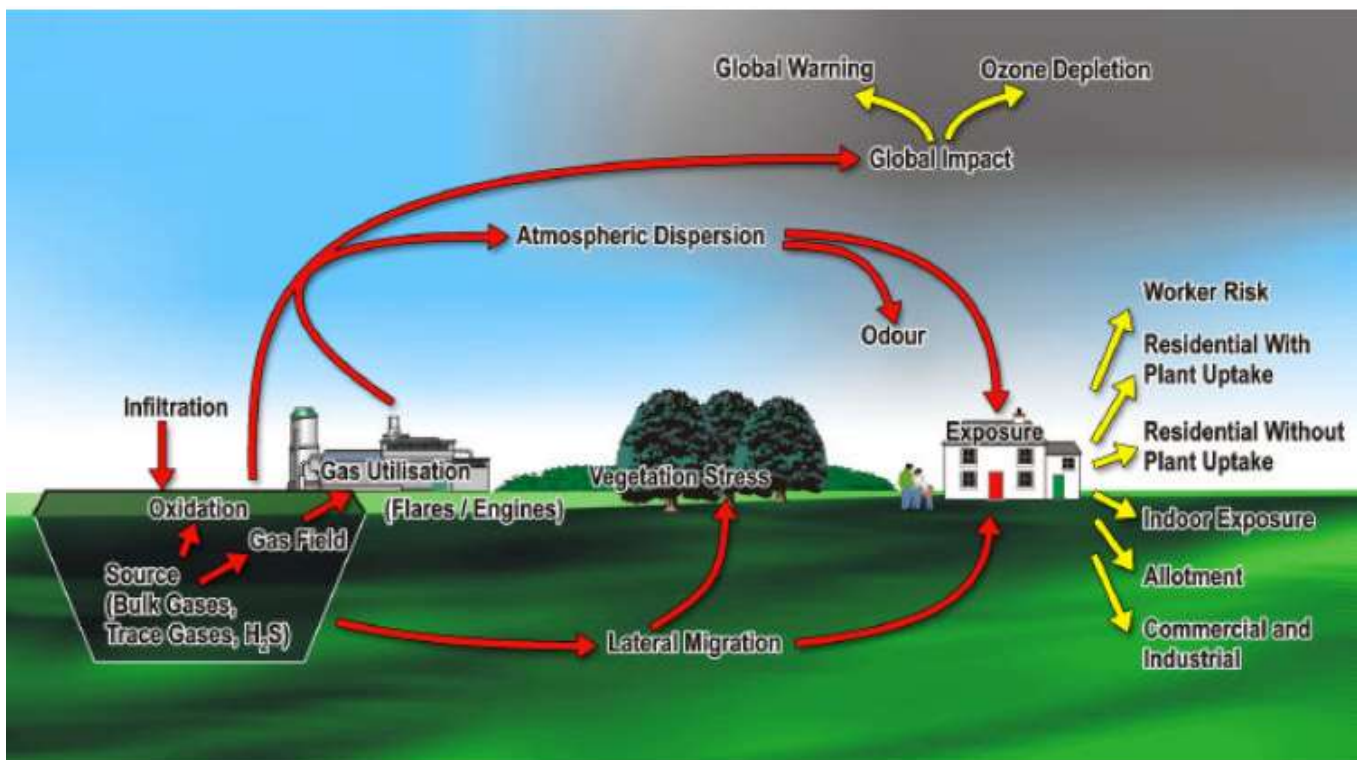

SEPTEMBER 2020



**SYBILLA Ltd.**  
*Managing Environment, Safety & Risk*

16 Ypsilandou, Maroussi GR 151 22 Athens, Greece  
 Tel +30210-8024244 / Fax +30210-6141245  
 e-mail : [mail@svbilla.gr](mailto:mail@svbilla.gr)

VAT No. EL 095487874



***Kozani - Ptolemaida Sanitary Landfill, Biogas and Runoff Processing Study***

The screenshot shows the 'Landfill Gas Emissions Model' software interface. The main window has a menu bar with 'File', 'Edit', 'Defaults', 'Parameters', 'Reports', 'Utilities', 'Window', and 'Help'. Below the menu bar are input fields for 'Year Opened' (1988), 'Current Year' (1998), and 'Capacity' (0 Mg). There is also a 'Waste Value' field (0) and checkboxes for 'Refuse in Place (Mg)' and 'Acceptance Rate (Mg/Yr)'. A secondary window titled 'Operating Parameters: \LANDFILL.000' displays a table with columns for 'Year', 'Acceptance Rate (Mg)', and 'Refuse In Place (Mg)'. The table contains data for years 1988 through 1998, with all values set to 0.000000E+00.

Year	Acceptance Rate (Mg)	Refuse In Place (Mg)
1988	0.000000E+00	0.000000E+00
1989	0.000000E+00	0.000000E+00
1990	0.000000E+00	0.000000E+00
1991	0.000000E+00	0.000000E+00
1992	0.000000E+00	0.000000E+00
1993	0.000000E+00	0.000000E+00
1994	0.000000E+00	0.000000E+00
1995	0.000000E+00	0.000000E+00
1996	0.000000E+00	0.000000E+00
1997	0.000000E+00	0.000000E+00
1998	0.000000E+00	0.000000E+00

<b>CONTRACTING ENTITY</b>	<b>PRODROMI –KARKANIAS ENVIRONMENTAL TECHNOLOGY AE</b>
<b>CONTRACT PRICE</b>	<b>CONFIDENTIAL</b>
<b>YEAR</b>	<b>2002</b>
<b>PROJECT TYPE</b>	<b>BIOGAS AND RUNOFF PROCESSING STUDY</b>
<b>LOCATION</b>	<b>ATHENS – PTOLEMAIDIA - KOZANI</b>



**SYBILLA Ltd.**  
*Managing Environment, Safety & Risk*

16 Ypsilandou, Maroussi GR 151 22 Athens, Greece  
Tel +30210-8024244 / Fax +30210-6141245  
e-mail : [mail@svbilla.gr](mailto:mail@svbilla.gr)

VAT No. EL 095487874



## ***Final Recycling and Composting Unit Study, Koraka Chania Sanitary Landfill***

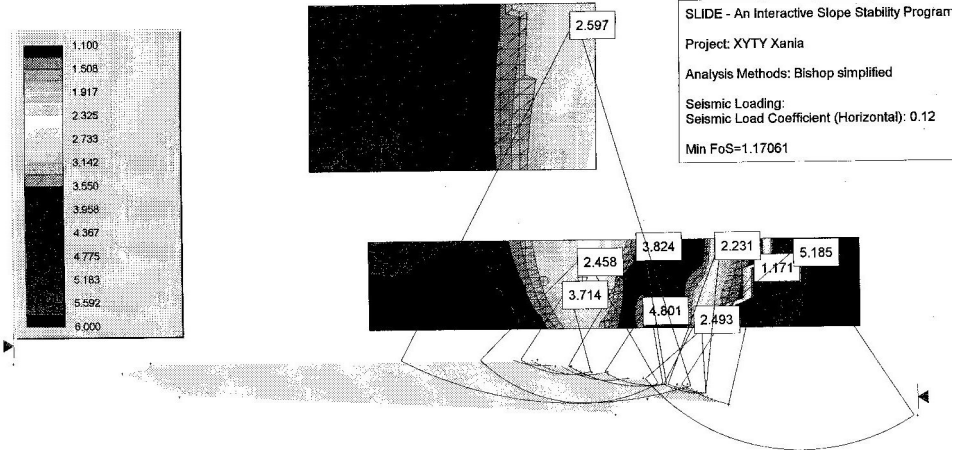

<b>CONTRACTING ENTITY</b>	<b>ELTER ATE- MUT</b>
<b>CONTRACT PRICE</b>	<b>CONFIDENTIAL</b>
<b>YEAR</b>	<b>2001</b>
<b>PROJECT TYPE</b>	<b>RECYCLING AND COMPOSTING UNIT STUDY</b>
<b>LOCATION</b>	<b>ATHENS – CHANIA</b>



SYBILLA Ltd.  
Managing Environment, Safety & Risk

16 Ypsilandou, Maroussi GR 151 22 Athens, Greece  
Tel +30210-8024244 / Fax +30210-6141245  
e-mail : [mail@svbilla.gr](mailto:mail@svbilla.gr)

VAT No. EL 095487874



### *Final Recycling and Composting Unit Study, Amari Sanitary Landfill*

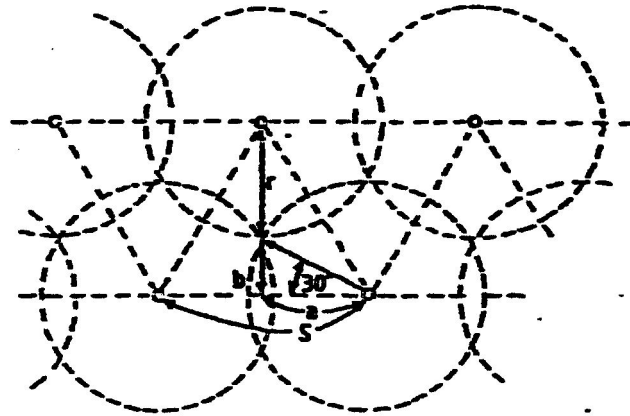

<b>CONTRACTING ENTITY</b>	<b>TECHNODOME CRETE AE - IOANNIS ZACHAROPOULOS ATE</b>
<b>CONTRACT PRICE</b>	<b>CONFIDENTIAL</b>
<b>YEAR</b>	<b>2002</b>
<b>PROJECT TYPE</b>	<b>RECYCLING AND COMPOSTING UNIT STUDY</b>
<b>LOCATION</b>	<b>ATHENS – CRETE</b>



SYBILLA Ltd.  
Managing Environment, Safety & Risk

16 Ypsilandou, Maroussi GR 151 22 Athens, Greece  
Tel +30210-8024244 / Fax +30210-6141245  
e-mail : [mail@svbilla.gr](mailto:mail@svbilla.gr)

VAT No. EL 095487874



### Western Attica Sanitary Landfill, Biogas and Runoff Processing Study

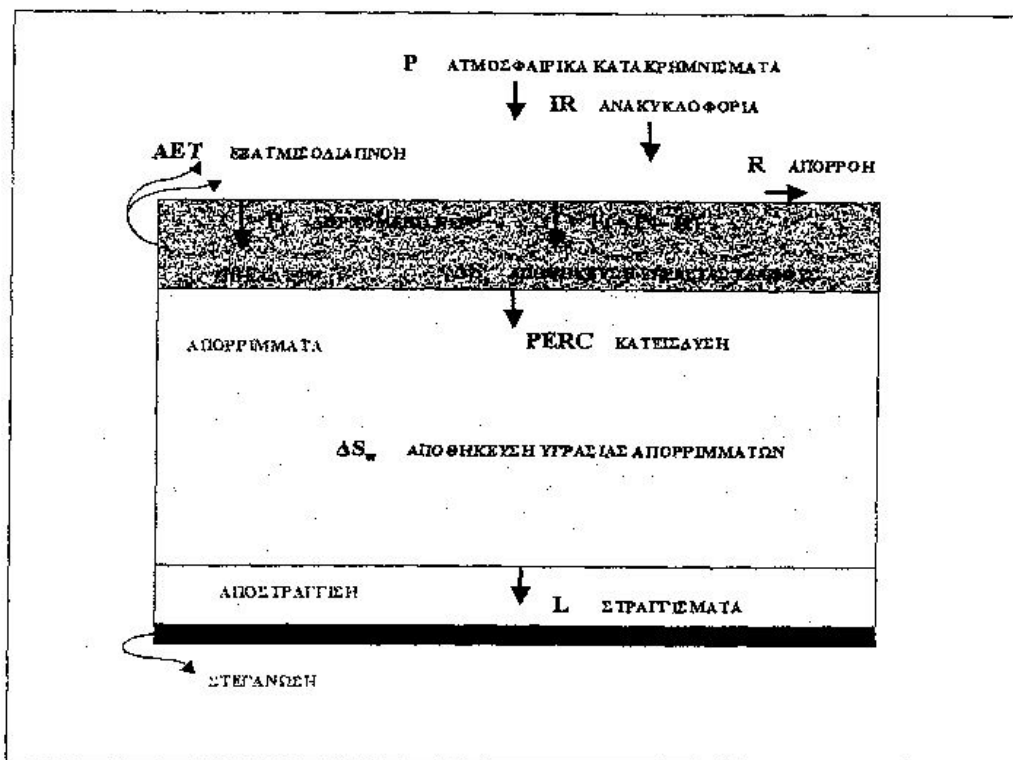

CONTRACTING ENTITY	THEMELIODOMI AE- A.KARKANIAS AE-I. KOUTROUMPIS EAE
CONTRACT PRICE	CONFIDENTIAL
YEAR	2001
PROJECT TYPE	BIOGAS AND RUNOFF PROCESSING STUDY
LOCATION	ATHENS



**SYBILLA Ltd.**  
*Managing Environment, Safety & Risk*

16 Ypsilandou, Maroussi GR 151 22 Athens, Greece  
Tel +30210-8024244 / Fax +30210-6141245  
e-mail : [mail@svbilla.gr](mailto:mail@svbilla.gr)

VAT No. EL 095487874



### **Waste Transport Station**

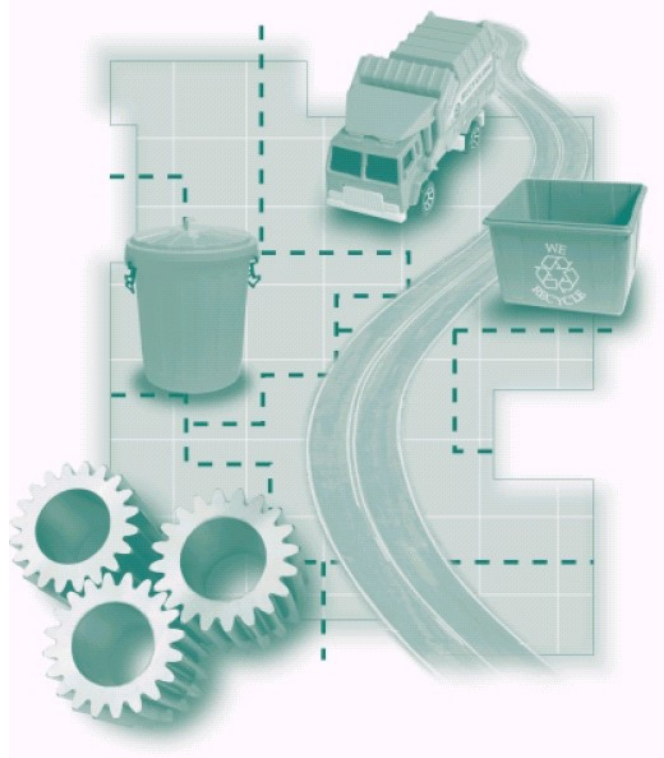

<b>CONTRACTING ENTITY</b>	<b>GANTZOULAS ATEE – DOM-KA AE - ARCHIMEDES ATE - EVOKAT AE</b>
<b>CONTRACT PRICE</b>	<b>CONFIDENTIAL</b>
<b>YEAR</b>	<b>2001-2003</b>
<b>PROJECT TYPE</b>	<b>BIOGAS AND RUNOFF PROCESSING STUDY</b>
<b>LOCATION</b>	<b>ATHENS</b>



**SYBILLA Ltd.**  
*Managing Environment, Safety & Risk*

16 Ypsilandou, Maroussi GR 151 22 Athens, Greece  
Tel +30210-8024244 / Fax +30210-6141245  
e-mail : [mail@svbilla.gr](mailto:mail@svbilla.gr)

VAT No. EL 095487874



### ***Sanitary Landfill in Samos, Biogas and Runoff Processing Study***

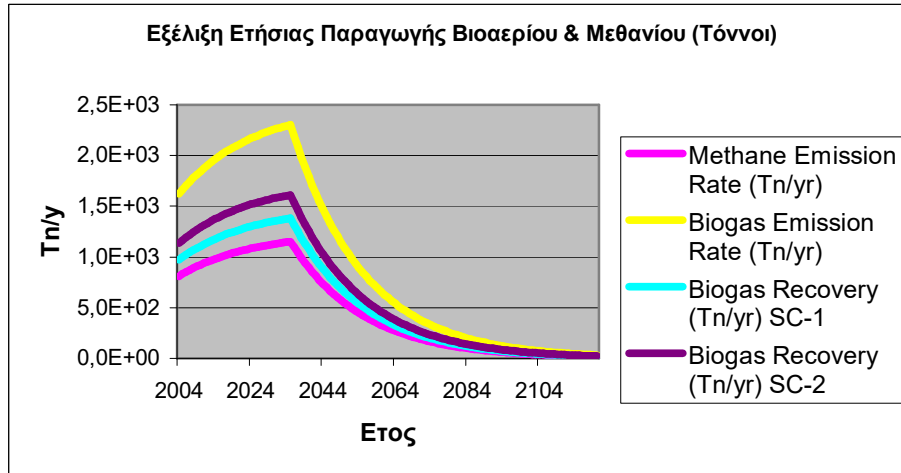

<b>CONTRACTING ENTITY</b>	<b>HYDRODYNAMICS AE – EYVOKAT AE</b>
<b>CONTRACT PRICE</b>	<b>CONFIDENTIAL</b>
<b>YEAR</b>	<b>2004</b>
<b>PROJECT TYPE</b>	<b>BIOGAS AND RUNOFF PROCESSING STUDY</b>
<b>LOCATION</b>	<b>ATHENS – SAMOS</b>



**SYBILLA Ltd.**  
*Managing Environment, Safety & Risk*

16 Ypsilandou, Maroussi GR 151 22 Athens, Greece  
Tel +30210-8024244 / Fax +30210-6141245  
e-mail : [mail@svbilla.gr](mailto:mail@svbilla.gr)

VAT No. EL 095487874



## Electric Furnace Slag Temporary Storage Site Study



<b>CONTRACTING ENTITY</b>	<b>HALIVOURGIKI AE</b>
<b>CONTRACT PRICE</b>	<b>CONFIDENTIAL</b>
<b>YEAR</b>	<b>2007</b>
<b>PROJECT TYPE</b>	<b>NON-HAZARDOUS INDUSTRIAL SOLID WASTE TEMPORARY STORAGE SITE STUDY</b>
<b>LOCATION</b>	<b>ATHENS – ASPROPYRGOS</b>





**SYBILLA Ltd.**  
*Managing Environment, Safety & Risk*

16 Ypsilandou, Maroussi GR 151 22 Athens, Greece  
Tel +30210-8024244 / Fax +30210-6141245  
e-mail : [mail@svbilla.gr](mailto:mail@svbilla.gr)

VAT No. EL 095487874



## "Waste Pre-Processing Unit" Final Study



<b>CONTRACTING ENTITY</b>	<b>ESDAK</b>
<b>CONTRACT PRICE</b>	<b>CONFIDENTIAL</b>
<b>YEAR</b>	<b>2007</b>
<b>PROJECT TYPE</b>	<b>WASTE PRE-PROCESSING STUDY</b>
<b>LOCATION</b>	<b>ATHENS – CRETE</b>



**SYBILLA Ltd.**  
*Managing Environment, Safety & Risk*

16 Ypsilandou, Maroussi GR 151 22 Athens, Greece  
 Tel +30210-8024244 / Fax +30210-6141245  
 e-mail : [mail@svbilla.gr](mailto:mail@svbilla.gr)

VAT No. EL 095487874



## Chemical-Technical Study for the Construction of the Silt Drying Unit of EEL Thessaloniki

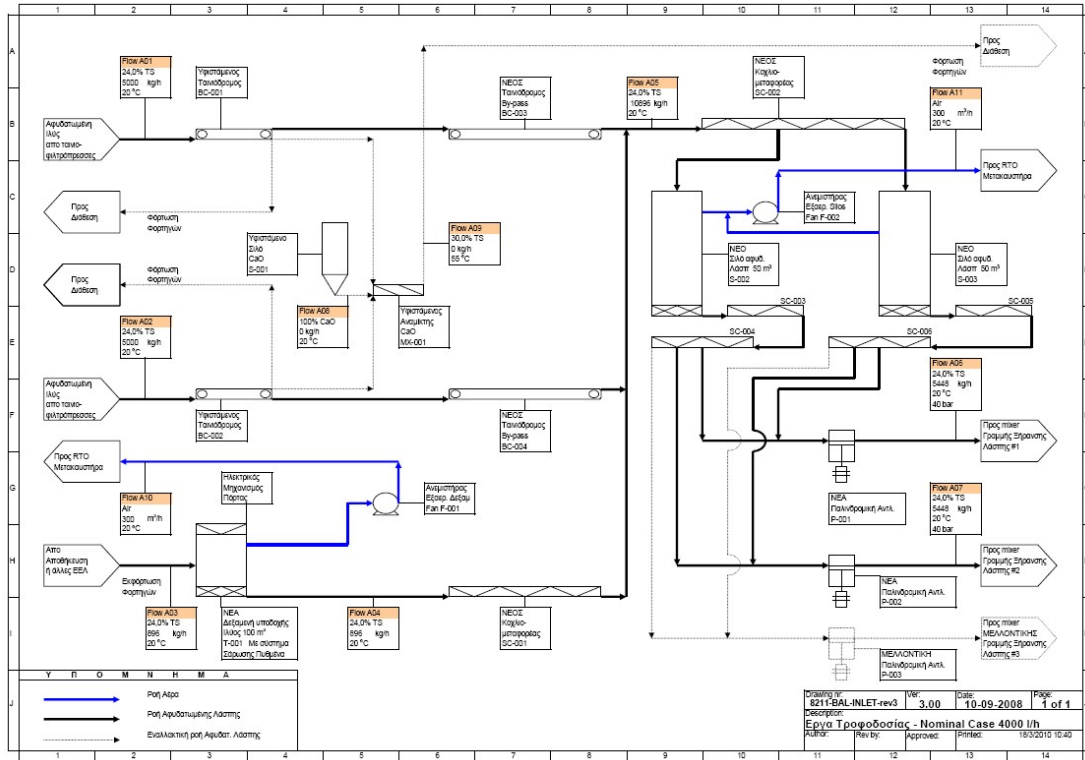

<b>CONTRACTING ENTITY</b>	<b>CH.D.KONSTANTINIDIS AE</b>
<b>CONTRACT PRICE</b>	<b>CONFIDENTIAL</b>
<b>YEAR</b>	<b>2008-2009</b>
<b>PROJECT TYPE</b>	<b>CHEMICAL-TECHNICAL STUDY</b>
<b>LOCATION</b>	<b>ATHENS – THESSALONIKI</b>



**SYBILLA Ltd.**  
*Managing Environment, Safety & Risk*

16 Ypsilandou, Maroussi GR 151 22 Athens, Greece  
 Tel +30210-8024244 / Fax +30210-6141245  
 e-mail : [mail@svbilla.gr](mailto:mail@svbilla.gr)

VAT No. EL 095487874



***Sanitary Landfill in Kinoura, Nisiros. Final Study***

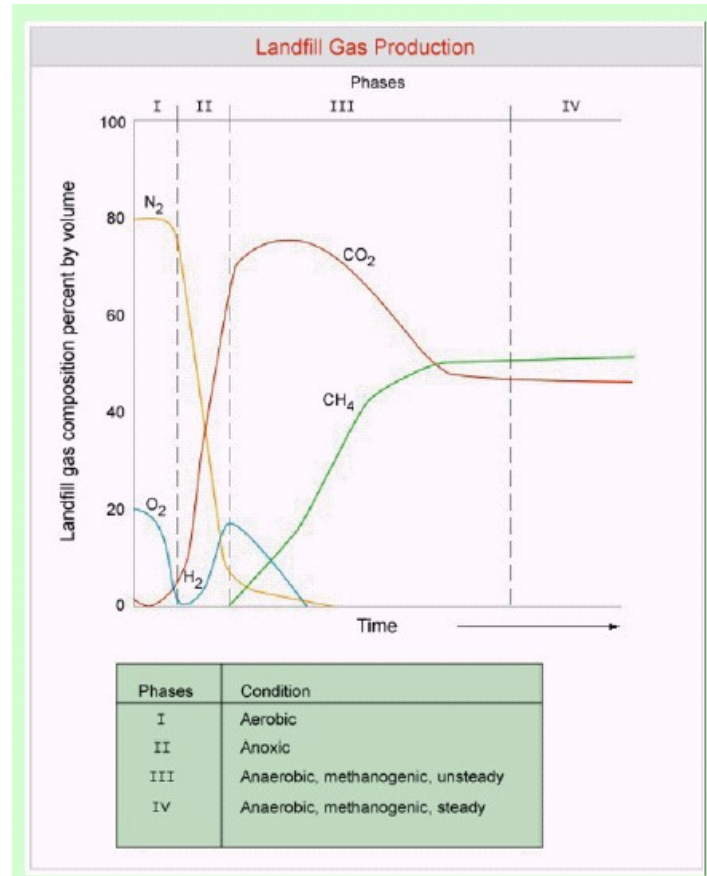

<b>CONTRACTING ENTITY</b>	<b>EUROMECHANICS-LERIAS GRIGORIS &amp; CO</b>
<b>CONTRACT PRICE</b>	<b>CONFIDENTIAL</b>
<b>YEAR</b>	<b>2011</b>
<b>PROJECT TYPE</b>	<b>BIOGAS AND RUNOFF PROCESSING STUDY</b>
<b>LOCATION</b>	<b>ATHENS – NISIROS</b>