



SYBILLA Ltd.
Managing Environment, Safety & Risk

16 Ypsilandou, Maroussi GR 151 22 Athens, Greece
Tel +30210-8024244 / Fax +30210-6141245
e-mail : mail@svbilla.gr

VAT No. EL 095487874



CAPABILITY STATEMENT

INDICATIVE PARTICIPATION IN SOLID WASTE AND PACKAGING HANDLING- RECYCLING – REUSE DESIGN AND IMPACT ASSESSMENT STUDIES

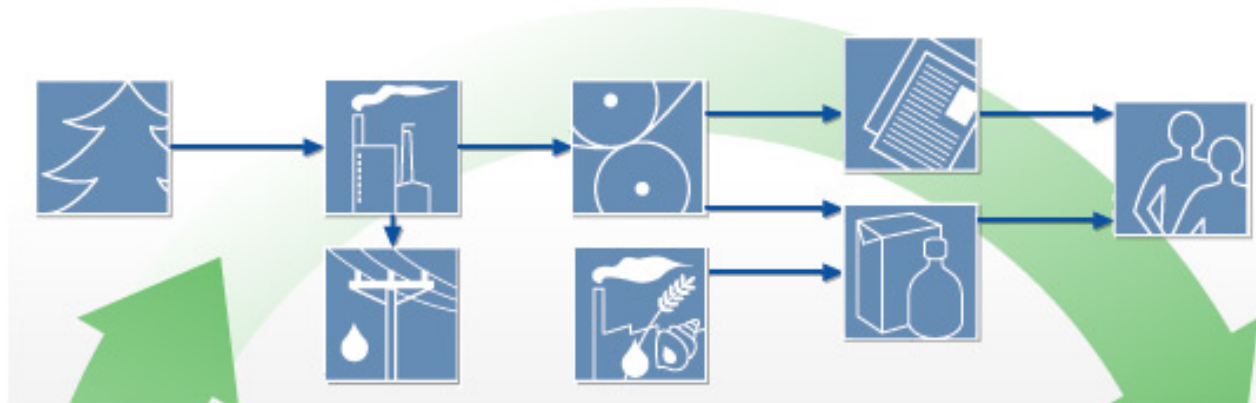

SEPTEMBER 2020



SYBILLA Ltd.
Managing Environment, Safety & Risk

16 Ypsilandou, Maroussi GR 151 22 Athens, Greece
Tel +30210-8024244 / Fax +30210-6141245
e-mail : mail@svbilla.gr

VAT No. EL 095487874



Final Recycling and Composting Unit Study, Koraka Chania Sanitary Landfill

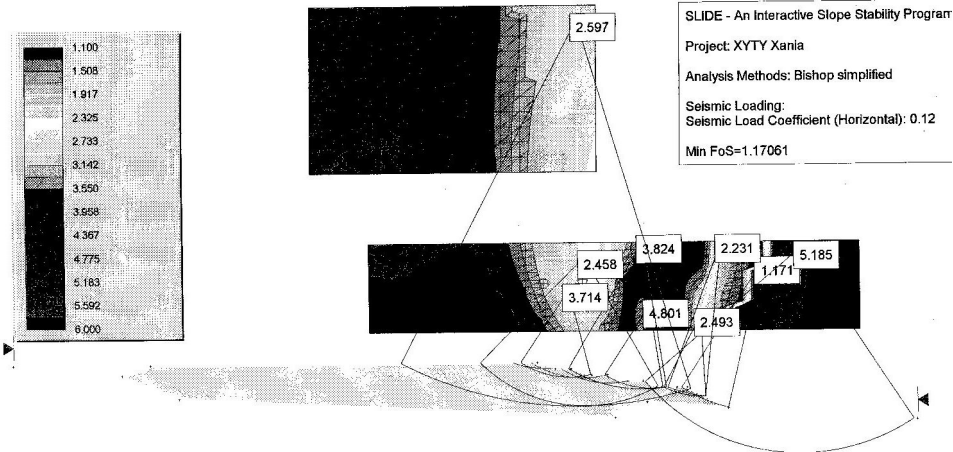

CONTRACTING ENTITY	ELTER ATE- MUT
CONTRACT PRICE	CONFIDENTIAL
YEAR	2001
PROJECT TYPE	RECYCLING AND COMPOSTING UNIT STUDY
LOCATION	ATHENS – CHANIA



SYBILLA Ltd.
Managing Environment, Safety & Risk

16 Ypsilandou, Maroussi GR 151 22 Athens, Greece
Tel +30210-8024244 / Fax +30210-6141245
e-mail : mail@svbilla.gr

VAT No. EL 095487874



ALTERNATIVE PAPER PROCESSING – RECYCLING SUPPORT STUDY



CONTRACTING ENTITY	GEX AE
CONTRACT PRICE	CONFIDENTIAL
YEAR	2004
PROJECT TYPE	ALTERNATIVE PAPER PROCESSING-RECYCLING SUPPORT STUDY
LOCATION	ATHENS



SYBILLA Ltd.
Managing Environment, Safety & Risk

16 Ypsilandou, Maroussi GR 151 22 Athens, Greece
Tel +30210-8024244 / Fax +30210-6141245
e-mail : mail@svbilla.gr

VAT No. EL 095487874



Electric and Electronic Waste Collection and Transport System Organization and Operation Study. Attica and Peloponessos Regions



CONTRACTING ENTITY	PGS LOGISTICS – LIAGI BROS AND CO TRANSPORT OE
CONTRACT PRICE	CONFIDENTIAL
YEAR	2005
PROJECT TYPE	WASTE COLLECTION AND TRASPOT SYSTEM STUDY
LOCATION	ATHENS - CORINTHIA



SYBILLA Ltd.
Managing Environment, Safety & Risk

16 Ypsilandou, Maroussi GR 151 22 Athens, Greece
 Tel +30210-8024244 / Fax +30210-6141245
 e-mail : mail@svbilla.gr

VAT No. EL 095487874



Electric and Electronic Waste Collection and Transport System Organization and Operation Study. South Aegean Region

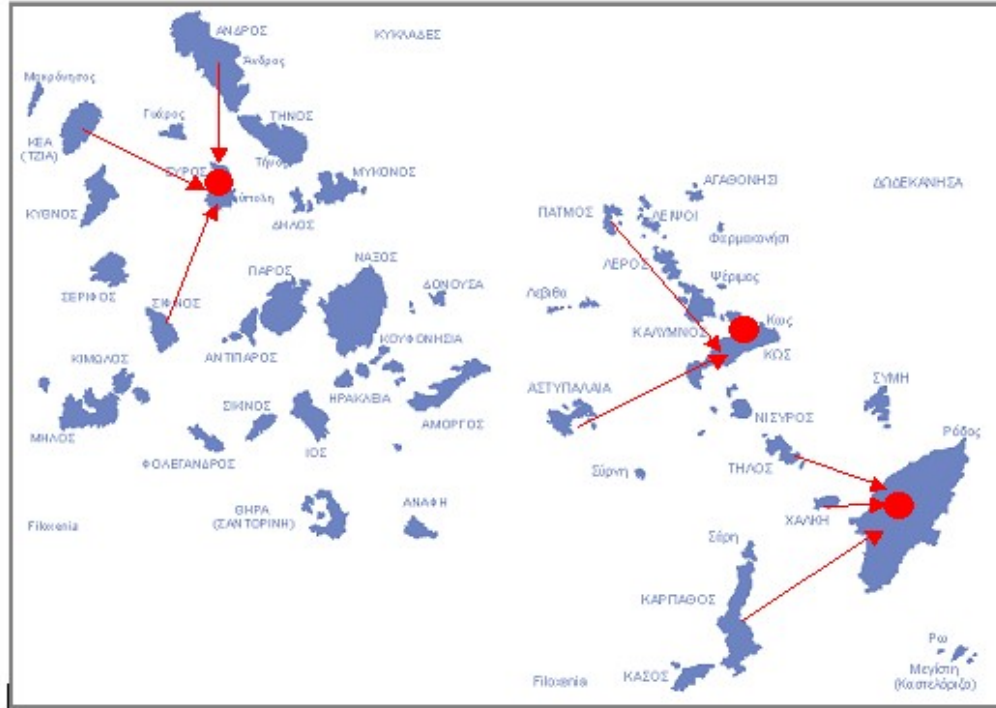

South Aegean Map

CONTRACTING ENTITY	PGS LOGISTICS – LIAGI BROS AND CO TRANSPORT OE
CONTRACT PRICE	CONFIDENTIAL
YEAR	2006
PROJECT TYPE	WASTE COLLECTION AND TRASPORT SYSTEM STUDY
LOCATION	ATHENS – S.AEGEAN



SYBILLA Ltd.
Managing Environment, Safety & Risk

16 Ypsilandou, Maroussi GR 151 22 Athens, Greece
Tel +30210-8024244 / Fax +30210-6141245
e-mail : mail@svbilla.gr

VAT No. EL 095487874



Electric and Electronic Waste Collection and Transport System Organization and Operation Study. Attica and Peloponessos Regions



CONTRACTING ENTITY	REWRITE RECYCLING & PRINTING SERVICES- K. ZERVAS & CO EE
CONTRACT PRICE	CONFIDENTIAL
YEAR	2006
PROJECT TYPE	SPENT PRINTER SUPPLIES COLLECTION AND TRANSPORT STUDY
LOCATION	ATHENS - PELOPONESSOS



SYBILLA Ltd.
Managing Environment, Safety & Risk

16 Ypsilandou, Maroussi GR 151 22 Athens, Greece
Tel +30210-8024244 / Fax +30210-6141245
e-mail : mail@svbilla.gr

VAT No. EL 095487874



Electric and Electronic Waste Collection and Transport System Organization and Operation Study. Attica and Peloponessos Regions



CONTRACTING ENTITY	REWRITE RECYCLING & PRINTING SERVICES- K. ZERVAS & CO EE
CONTRACT PRICE	CONFIDENTIAL
YEAR	2006
PROJECT TYPE	SPENT PRINTER SUPPLIES COLLECTION AND TRANSPORT STUDY
LOCATION	ATHENS - PELOPONESSOS



SYBILLA Ltd.
Managing Environment, Safety & Risk

16 Ypsilandou, Maroussi GR 151 22 Athens, Greece
Tel +30210-8024244 / Fax +30210-6141245
e-mail : mail@svbilla.gr

VAT No. EL 095487874



XALIVOURGIKI AE SLAG DISPOSAL INVESTIGATION STUDY



Αντιολισθηρή Σκωρία 5-12mm



Αντιολισθηρή Σκωρία 12-16mm



Σκύρα οδοποιίας τύπου 3A

CONTRACTING ENTITY	HALIVOURGIKI AE
CONTRACT PRICE	CONFIDENTIAL
YEAR	2006
PROJECT TYPE	SOLID INDUSTRIAL WASTE HANDLING STUDY
LOCATION	ATTICA



SYBILLA Ltd.
Managing Environment, Safety & Risk

16 Ypsilandou, Maroussi GR 151 22 Athens, Greece
 Tel +30210-8024244 / Fax +30210-6141245
 e-mail : mail@svbilla.gr

VAT No. EL 095487874



EDIAS A.B.E.E ELECTRIC AND ELECTRONIC DEVICE RECYCLING FACILITIES IN ASPROPYRGOS, ENVIRONMENTAL IMPACT ASSESSMENT STUDY

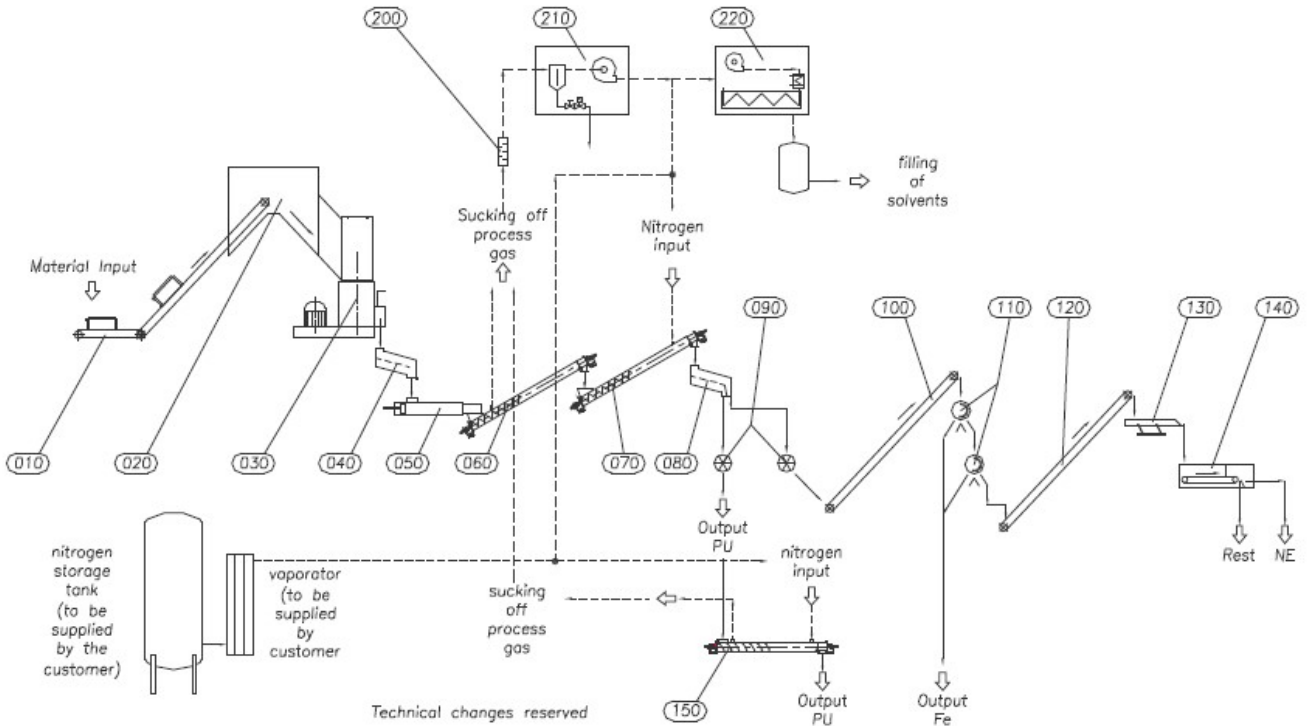

CONTRACTING ENTITY	MECHANICA AE
CONTRACT PRICE	CONFIDENTIAL
YEAR	2007
PROJECT TYPE	ENVIRONMENTAL IMPACT ASSESSMENT STUDY
LOCATION	ATHENS – ASPROPYRGOS



SYBILLA Ltd.
Managing Environment, Safety & Risk

16 Ypsilandou, Maroussi GR 151 22 Athens, Greece
Tel +30210-8024244 / Fax +30210-6141245
e-mail : mail@svbilla.gr

VAT No. EL 095487874



Detailed Study of Heraklion Crete Urban Solid Waste Facility



CONTACTOR	«ΚΟΙΝΟΠΡΑΞΙΑ ΔΟΜΙΚΗ ΚΡΗΤΗΣ Α.Ε. - ΑΤΕΣΕ Α.Ε. - E.M.I.T. ERCOLE MARELLI IMPIANTI TECNOLOGICI S.P.A.»
CONTACT AMOUNT	CONFIDENTIAL
YEAR	2007
SHORT DESCRIPTION	CHEMICAL ENGINEERING DESIGN BASIC AND DETAILED STUDY. URBAN SOLID WASTE TREATMENT FACILITY
LOCATION	GREECE/ATHENS-CRETE



ΠΡΟΜΕΛΕΤΗ ΣΤΟΙΧΕΙΩΝ ΠΑΡΑΓΩΓΗΣ ΟΙΚΙΑΚΩΝ ΚΑΙ ΜΗ ΑΠΟΡΡΙΜΜΑΤΩΝ Β.ΒΟΙΩΤΙΑΣ

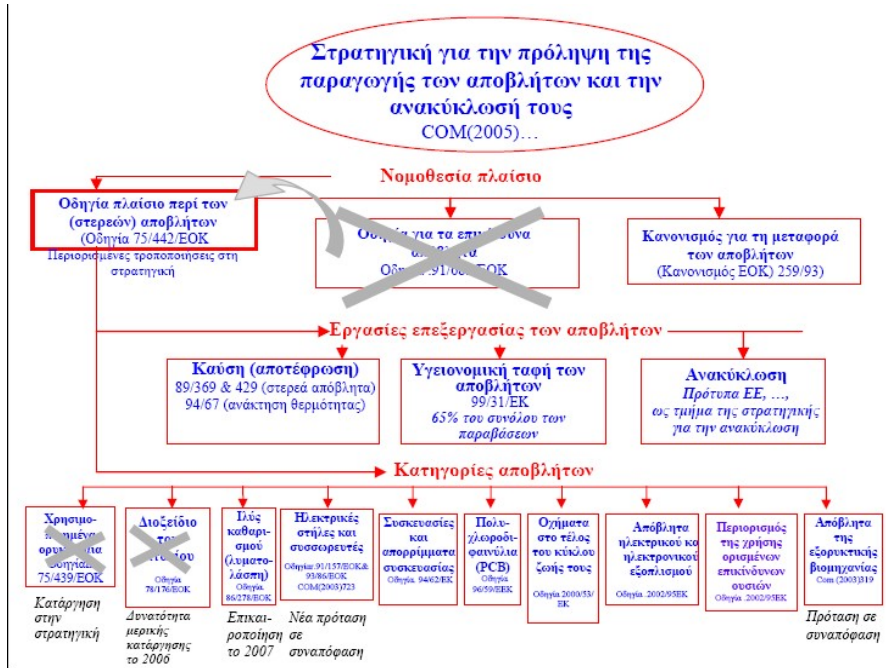

CONTRACTING ENTITY	INTRAKAT AE
CONTRACT PRICE	CONFIDENTIAL
YEAR	2008
PROJECT TYPE	MUNICIPAL AND NON-MUNICIPAL WASTE DATA PRE-STUDY
LOCATION	ATHENS - VOIOTIA



SYBILLA Ltd.
Managing Environment, Safety & Risk

16 Ypsilandou, Maroussi GR 151 22 Athens, Greece
 Tel +30210-8024244 / Fax +30210-6141245
 e-mail : mail@svbilla.gr

VAT No. EL 095487874



DETAILED DESIGN STUDY OF THESSALONIKI URBAN SLUDGE DRYING UNIT

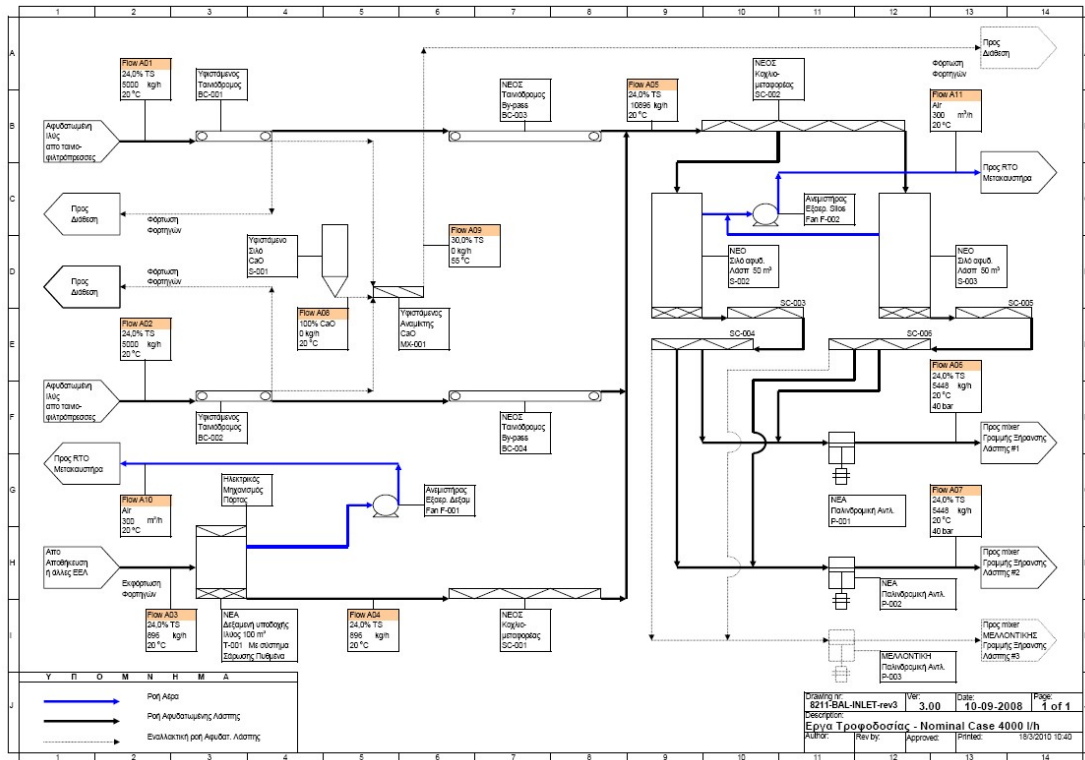

CONTACTOR	XP.Δ.ΚΩΣΤΑΝΤΙΝΙΔΗΣ ΑΕ
CONTACT AMOUNT	CONFIDENTIAL
YEAR	2008-2009
SHORT DESCRIPTION	CHEMICAL ENGINEERING DESIGN BASIC AND DETAILED STUDY. SLUDGE DRYING UNIT
LOCATION	GREECE/ATHENS -THESSALONIKI



SYBILLA Ltd.
Managing Environment, Safety & Risk

16 Ypsilandou, Maroussi GR 151 22 Athens, Greece
 Tel +30210-8024244 / Fax +30210-6141245
 e-mail : mail@svbilla.gr

VAT No. EL 095487874



Design of Nisyros Landfill Facility at Kinoura.

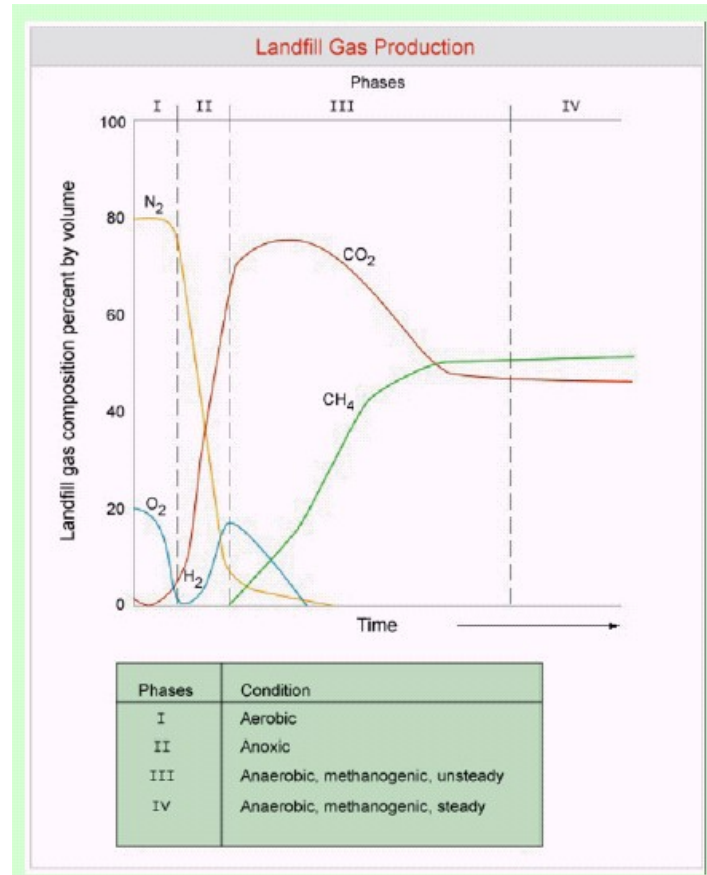

CONTRACTING ENTITY	EUROMECHANICS – LERIAS GRIGORIS & CO EE
CONTRACT PRICE	CONFIDENTIAL
YEAR	2011
PROJECT TYPE	BIOGAS AND RUNOFF PROCESSING STUDY
LOCATION	ATHENS – NISIROS



SYBILLA Ltd.
Managing Environment, Safety & Risk

16 Ypsilandou, Maroussi GR 151 22 Athens, Greece
 Tel +30210-8024244 / Fax +30210-6141245
 e-mail : mail@svbilla.gr

VAT No. EL 095487874



**CHEMICAL ENGINEERING INTEGRATED SOLID WASTE TREATMENT INSTALLATION
 EPC CONTRACTOR STUDY FOR SERRES REGION (PPP PROJECT)**

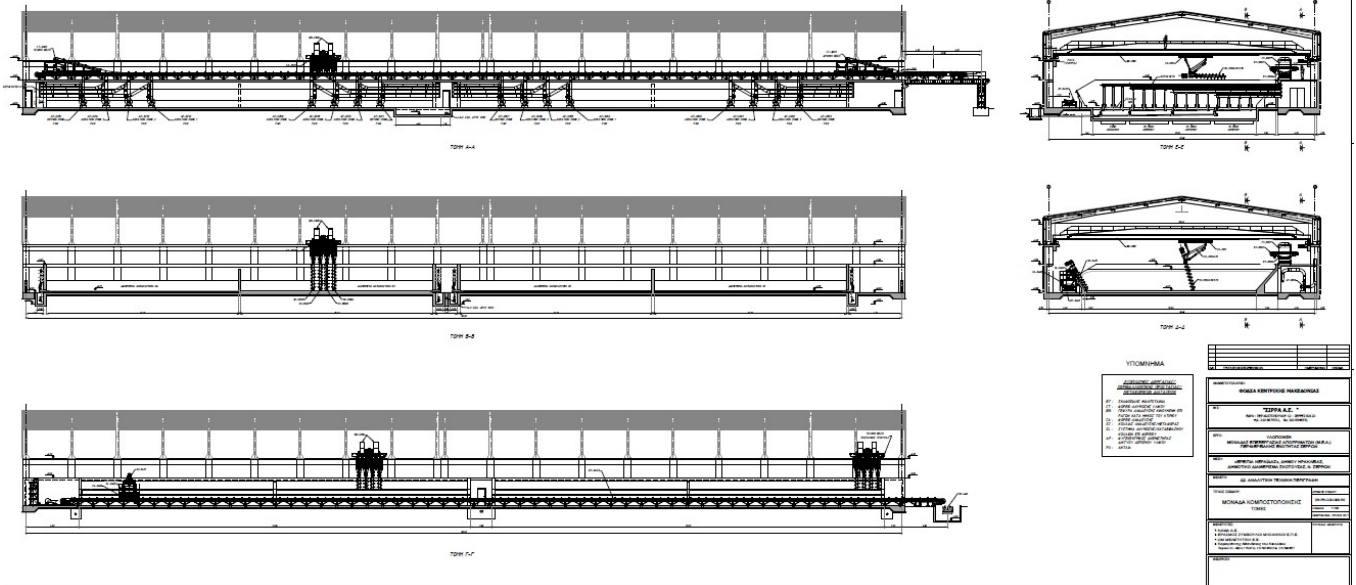

CONTRACTING ENTITY	SIRRA AE.
CONTRACT PRICE	CONFIDENTIAL
YEAR	2017
PROJECT TYPE	CHEMICAL ENGINEERING INTEGRATED SOLID WASTE TREATMENT INSTALLATION EPC CONTRACTOR STUDY FOR SERRES REGION (PPP PROJECT)
LOCATION	GREECE/ATHENS-CENTRAL MACEDONIA



SYBILLA Ltd.
Managing Environment, Safety & Risk

16 Ypsilandou, Maroussi GR 151 22 Athens, Greece
Tel +30210-8024244 / Fax +30210-6141245
e-mail : mail@svbilla.gr

VAT No. EL 095487874



CHEMICAL ENGINEERING INTEGRATED SOLID WASTE TREATMENT INSTALLATION EPC CONTRACTOR STUDY FOR 2nd VIOTIA REGION

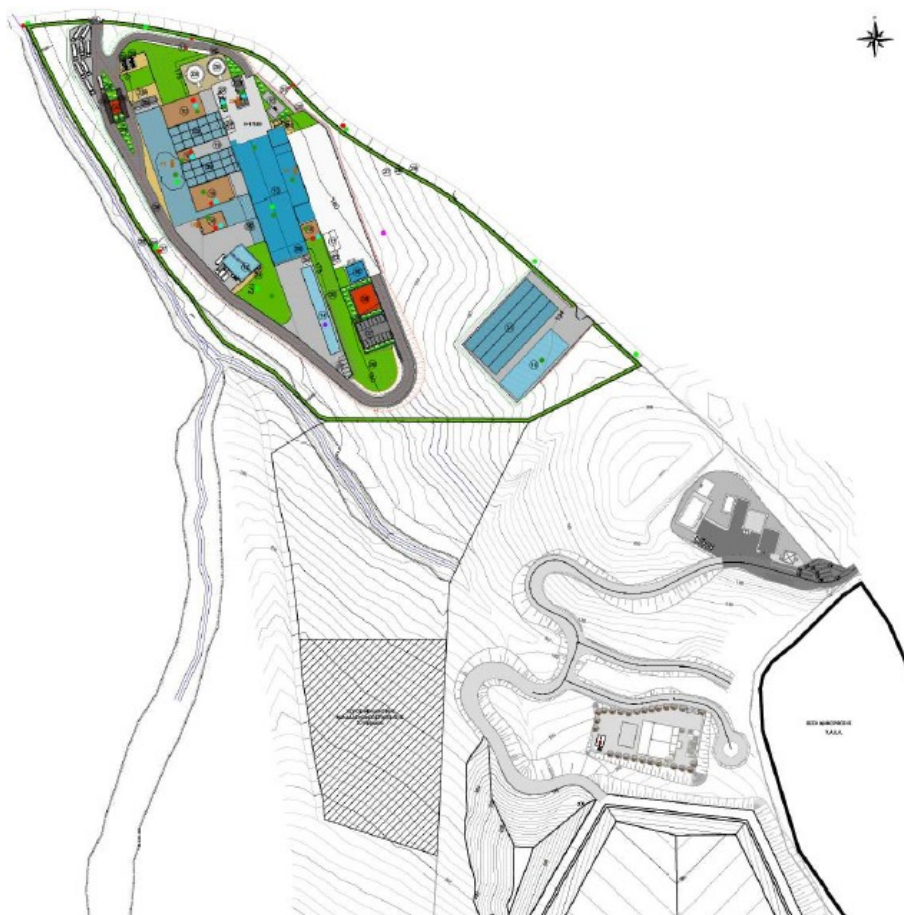

ΑΝΑΘΕΤΟΥΣΑ ΑΡΧΗ	INTRAKAT AE-WATT AE .
ΠΟΣΟ ΣΥΜΒΑΣΗΣ	CONFIDENTIAL
ΕΤΗ	2019
ΕΙΔΟΣ ΕΡΓΟΥ	CHEMICAL ENGINEERING INTEGRATED SOLID WASTE TREATMENT INSTALLATION EPC CONTRACTOR STUDY FOR 2nd VIOTIA REGION
ΤΟΠΟΘΕΣΙΑ	ATHENS-VIOTIA